

 AIR COMFORT
AIR TREATMENT



eQ PRIME COMMISSIONING



CONTENTS

1.	Unit parts	4
2.	Safety regulations	10
3.	Commissioning	11
4.	Pressure balance over rotor	12
5.	Handheld terminal.....	13
6.	Overview of the menu structure.....	14
7.	Start page/Main overview.....	15
8.	Main index/System overview.....	16
9.	Air handling unit	18
10.	ReCooler HP	45
11.	Web interface.....	48
12.	Modem/sms	50
13.	Questions and answers.....	51
14.	Alarm guide.....	54
15.	Updating from an SD card	62

Limits of responsibilities

Although Fläkt Woods has tested and reviewed the documentation contained in this manual, Fläkt Woods makes no warranty, neither expressed nor implied, with respect to this manual, including its quality, performance, or fitness for a particular purpose.

Fläkt Woods shall under no circumstances be liable for direct, indirect, special, incidental or

consequential damage arising from the use or the inability to use information contained in this manual. Fläkt Woods reserves the right to revise this publication at any time and to make changes to its content without prior notice and has no duty to provide notice to previous or current owners with respect to such revisions or changes.

Unit parts

eQ PRIME size 005-008

Simplified overview of installed components

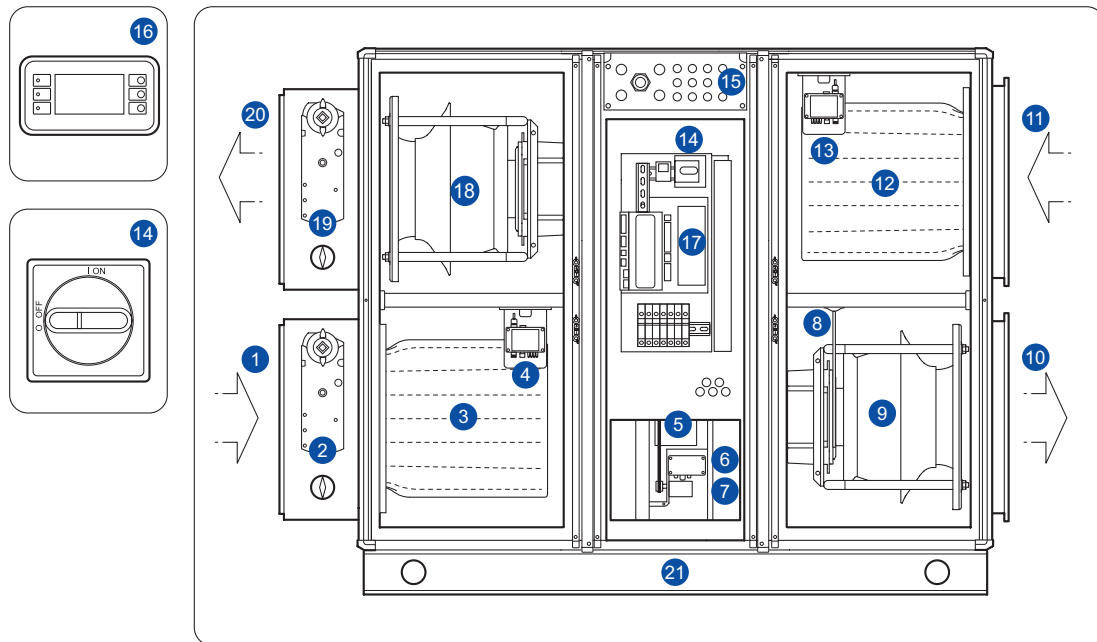

The pictured unit has the supply air at the bottom right-hand side. The unit is available with the supply air either at the top or at the bottom, and on the right or the left.

1

1. Outdoor air
2. Outdoor air damper with damper actuator
3. Supply air filter
4. Multifunction sensor (extract air flow, supply air filter, outdoor temperature)
5. Rotary heat exchanger
6. Drive system rotary heat exchanger
7. Drive motor rotary heat exchanger
8. Temperature sensor efficiency
9. Supply air fan with EC motor
10. Supply air
11. Extract air
12. Extract air filter
13. Multifunction sensor (supply air flow, extract air filter, extract air temperature)
14. Lockable main circuit breaker
15. Cable glands
16. Handheld terminal
17. AHU controller
18. Extract air fan with EC motor
19. Exhaust air damper with damper actuator
20. Exhaust air
21. Base frame

Unit parts

eQ PRIME size 011-018

Simplified overview of installed components

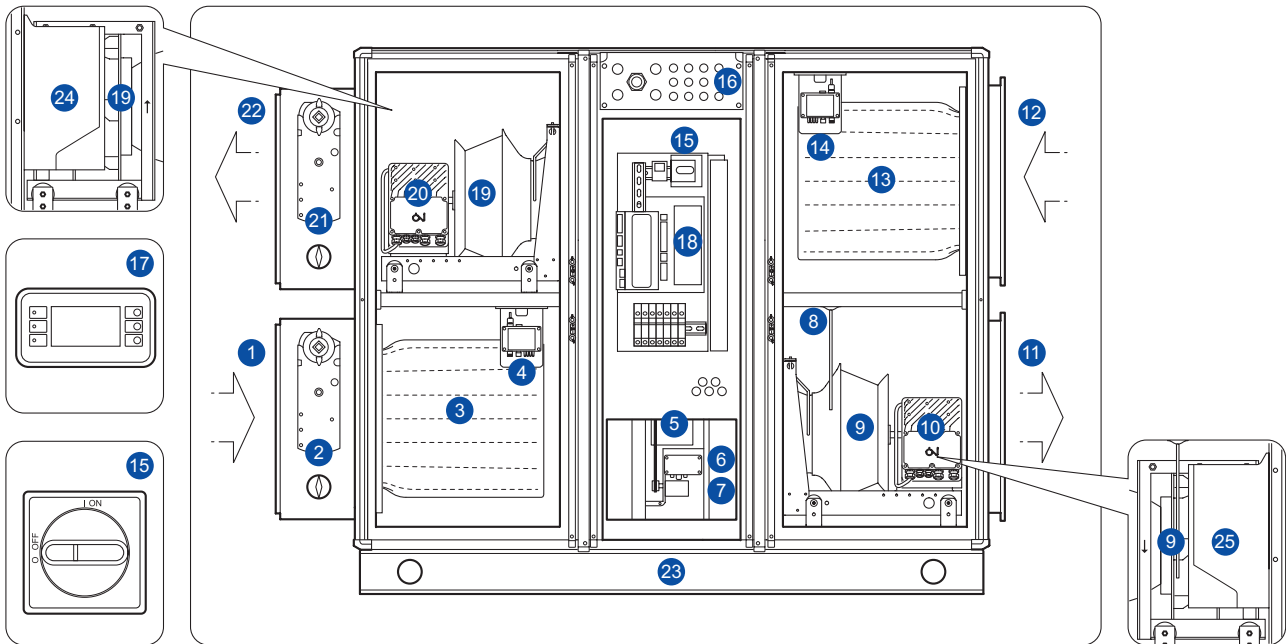

The pictured unit has the supply air at the bottom right-hand side. The unit is available with the supply air either at the top or at the bottom, and on the right or the left.

1

1. Outdoor air
2. Outdoor air damper with damper actuator
3. Supply air filter
4. Multifunction sensor (extract air flow, supply air filter, outdoor temperature)
5. Rotary heat exchanger
6. Drive system rotary heat exchanger
7. Drive motor rotary heat exchanger
8. Temperature sensor efficiency
9. Supply air fan with motor
10. Frequency converter OJ-DV supply air
11. Supply air
12. Extract air
13. Extract air filter
14. Multifunction sensor (supply air flow, extract air filter, extract air temperature)
15. Lockable main circuit breaker
16. Cable glands
17. Handheld terminal
18. AHU controller
19. Extract air fan with motor
20. Frequency converter OJ-DV extract air
21. Exhaust air damper with damper actuator
22. Exhaust air
23. Base frame
24. Frequency converter extract air*
25. Frequency converter supply air*

*Optional for IE2 Motor.

Unit parts

eQ PRIME size 023-050

Simplified overview of installed components

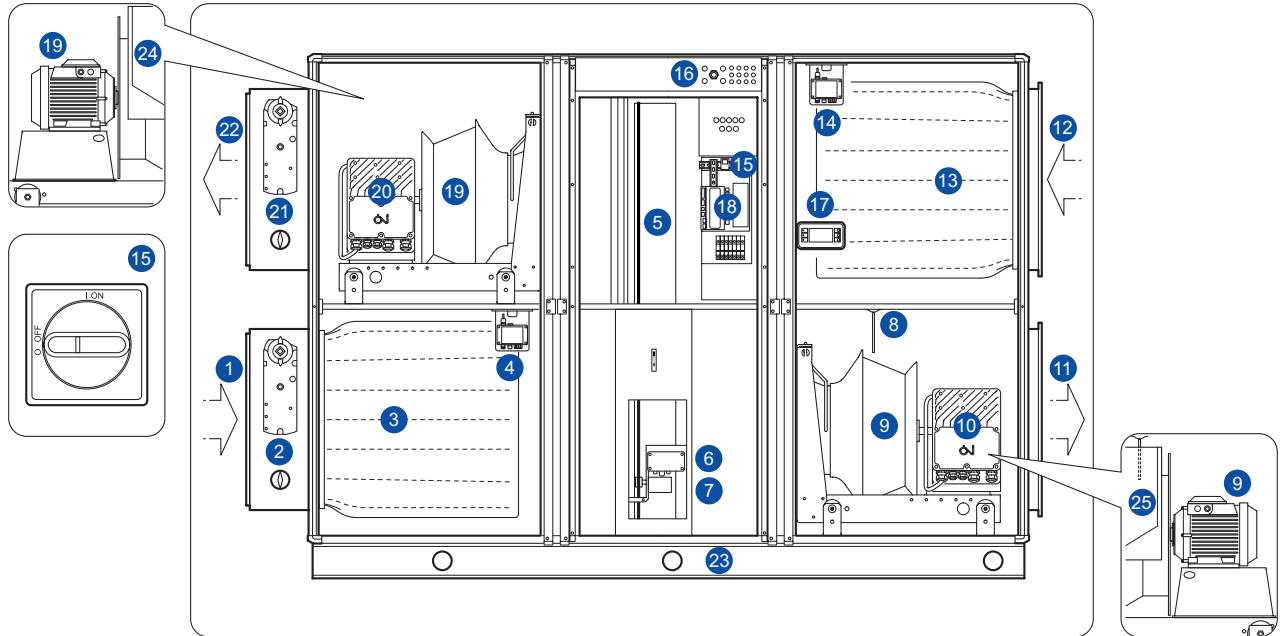

1

The pictured unit has the supply air at the bottom right-hand side. The unit is available with the supply air either at the top or at the bottom, and on the right or the left.

1. Outdoor air
2. Outdoor air damper with damper actuator
3. Supply air filter
4. Multifunction sensor (extract air flow, supply air filter, outdoor temperature)
5. Rotary heat exchanger
6. Drive system rotary heat exchanger
7. Drive motor rotary heat exchanger
8. Temperature sensor efficiency
9. Supply air fan with motor
10. Frequency converter OJ-DV supply air
11. Supply air
12. Extract air
13. Extract air filter
14. Multifunction sensor (supply air flow, extract air filter, extract air temperature)
15. Lockable main circuit breaker
16. Cable glands
17. Handheld terminal
18. AHU controller
19. Extract air fan with motor
20. Frequency converter OJ-DV extract air
21. Exhaust air damper with damper actuator
22. Exhaust air
23. Base frame
24. Option IE2 Motor - Frequency converter extract air
25. Option IE2 Motor - Frequency converter supply air

Unit parts

eQ PRIME – Active mixing

Simplified overview of installed components



1. Outdoor air
2. Supply air
3. Extract air
4. Exhaust air
5. Mixing damper
6. Return air
7. Extract air damper

1

Unit parts

eQ PRIME – ReCooler HP

Simplified overview of installed components

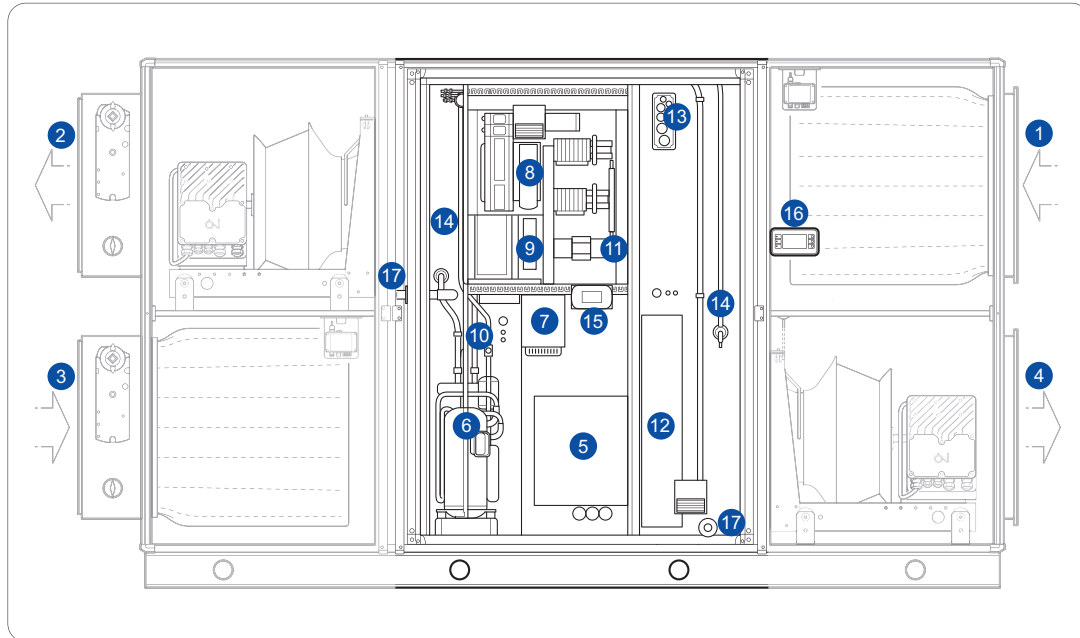

1

1. Outdoor air
2. Supply air
3. Extract air
4. Exhaust air
5. Rotary heat exchanger - service hatch
6. Compressor
7. Inverter for compressor
8. AHU controller
9. Control system for the ReCooler
10. 4-way valve
11. Main switch disconnect
12. Electrical heater (with both auto reset, manual reset)
13. Cable glands
14. Electrical expansion valves
15. Handheld terminal for the ReCooler
16. Handheld terminal for AHU
17. Drainage

Unit parts

eQ PRIME – Counterflow

Simplified overview of installed components

Size 005 – 008

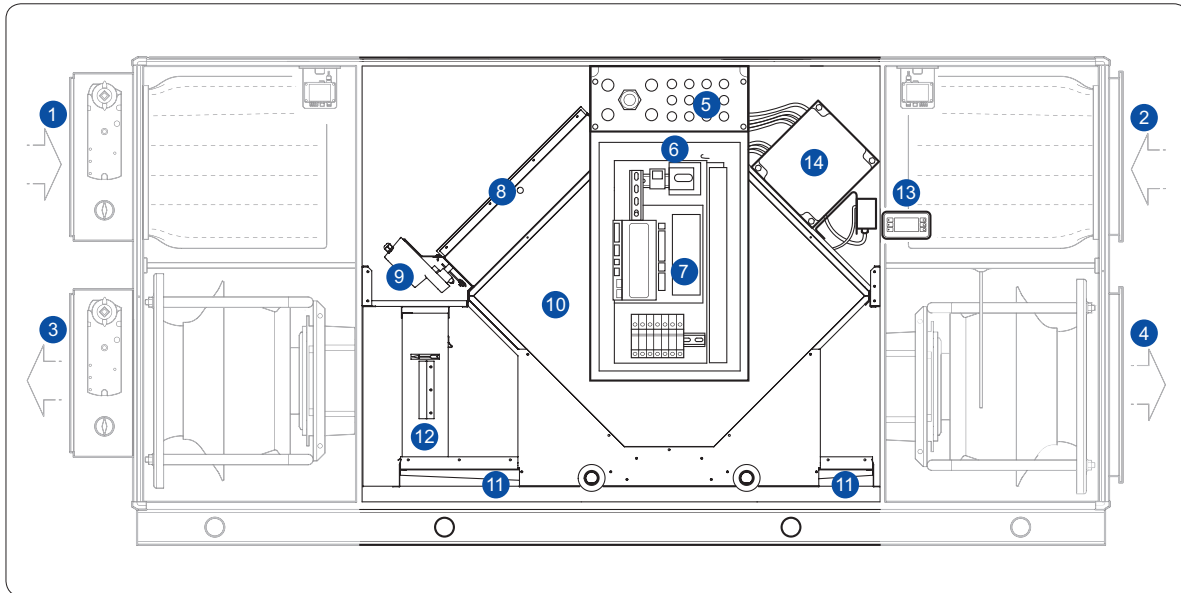

Size 011 – 032

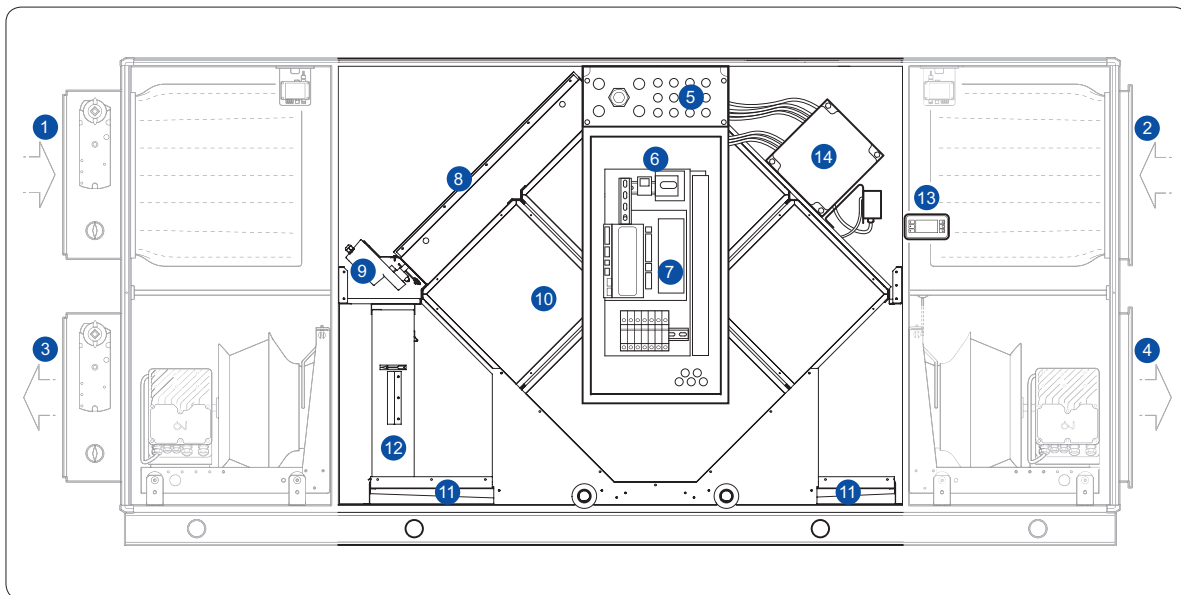

1

- | | |
|----------------------------------|--------------------------|
| 1. Outdoor air | 8. Damper |
| 2. Extract air | 9. Actuator |
| 3. Exhaust air | 10. Heat exchanger |
| 4. Supply air | 11. Drain tray |
| 5. Cable glands | 12. Droplet eliminator |
| 6. Lockable main circuit breaker | 13. Display |
| 7. AHU controller | 14. Control unit defrost |

Safety regulations



Warning!

Before the air handling unit is commissioned, any open connections must be protected with protective mesh.

The air handling unit may not be commissioned until all electrical and mechanical safety apparatus has been installed.

Take great care when opening the air purging connection for the hot water supplied to the air heater. Risk of liquid knock or steam leakage.

If the eQ PRIME is dismantled, Fläkt Woods will cease to be responsible for its compliance with the specified tightness class.

The unit's doors are equipped with lockable handles. Always leave the unit locked and store the keys out of reach of unauthorised persons.

Follow the separate instructions for replacement of casing parts.

Local rules and regulations must always be followed.

Make sure you have carefully read and understood these instructions before commissioning the unit.

The unit's owner or installation firm is responsible for ensuring that the valid safety rules are followed.

No unauthorised persons may operate the unit. Only qualified staff members may use the unit.

Make sure that all the included parts and tools used for installing the unit are removed before operating the unit.



Main circuit breaker/Safety circuit breaker

The eQ PRIME has an integrated safety circuit breaker in the electrical equipment cubicle. Access to the rotary switch is on the outside of the unit. Parts that are powered separately, such as electric heaters, require a separate safety circuit breaker.

Prior to servicing or inspection, all the unit's safety circuit breakers must remain switched off for at least 1 minute before opening the inspection hatches. All the safety apparatus must be reset before restarting.

The safety circuit breaker may not be used for normal starting and stopping of the unit. This must be done from the handheld terminal.

Commissioning

1. Follow the instructions below regarding any parts that are included in your unit.
Start by switching off the electricity supply.
2. Check that the unit is horizontal.
3. Check that the inspection doors open and close smoothly. Adjust the hinges if necessary.
4. Check that the unit is clean on the inside and outside.
5. **Dampers with actuators** – Check that the connected dampers are in the closed position when the stepper motor is in its end position.
6. **Filter** – Check that the filter cassettes are in place and the locking system is closed.
7. **Rotor** – Check that the rotary heat exchanger rotates easily when pushed manually. If it does not, the rotor on the eQ PRIME 023-050 can be adjusted.
8. **Manometers and flow metering instruments** – Check that the instruments are set on 0 and connected correctly (+/-) to the test points.
9. For checking other functions, follow separate instructions.
10. Check that all the safety restraints have been removed.
11. Switch on the main power switch.
12. The basic control system settings are factory configured, but certain settings must be customised for each installation. Finish configuring the control system using the handheld terminal. See page 13 for further details.
 - a) Log in. Password 2000
 - b) Set desired language
 - c) Set date and time
 - d) Set fan control setpoints
 - e) Set temperature setpoints
 - f) Set final pressure drop for the filters
 - g) Set desired operating period
13. Set the operating switch to Auto. See page 15 for further details.
14. Adjust the duct system and the air terminal devices.
15. Adjust the unit's pressure balance, see page 12.
16. If the unit has active mixing. Run 0-calibration. See section Active mixing.



Questions and answers, page 51
Alarm guide, page 54

Pressure balance over rotor

If the eQ unit is to be used in an application where it is important to prevent air leaking from the extract air to the supply air, ensure that the air leakage direction is correct. Static pressure (greater negative pressure) must be lower in the extract air than the supply air.

Any risk of leakage in the wrong direction is indicated in the specifications for the eQ unit if there is a value for extra restriction.

On the eQ PRIME, the correct leakage direction is ensured by increasing the pressure drop by installing pressure adjustment plates in front of the filter to further restrict the extract air flow. The pressure adjustment plates are perforated panels that can be spaced at various distances depending on how much air restriction is needed. The pressure adjustment plates are available as an accessory for the eQ unit, and must be ordered separately.

Fitting of pressure adjustment plates

The pressure adjustment plates are supplied unfitted along with the unit. Separate installation instructions are included with the plates. The number of pressure adjustment plates supplied depends on the size of the unit. Enough plates are supplied to cover the whole duct opening. The number of pressure adjustment plates required for the unit depends on the degree of extra restriction needed. To fit the plates, bend them and wedge them into the filter frame.

Adjusting the extra restriction

The extra restriction should be adjusted after the unit and duct system are fully installed and ready for operation, so that the pressure difference between the extract air and supply air sides can be measured.

Connect a differential pressure meter to the unit's measurement nipples. The nipples are intended for use with differential pressure and/or flow meters (U-tube type) over the fan and filter. If such meters are connected to the unit, they must be disconnected while adjustment is taking place. Metering must be done over the nipples on the side that is downstream from the rotor in the supply air flow. Connect one of the contacts on the pressure drop meter to the "+" connection on the fan section and the "-" connection on the filter section (see figure).

Please note that it is the difference in negative pressure that is measured.

1. Start the unit on the chosen operating point.
2. Measure the pressure difference – if the negative pressure is lower on the extract air side, increase the extra restriction.
3. Stop the unit.
4. Install one or several pressure adjustment plates.

Repeat steps 1-4 until the pressure difference is in the correct direction.

To prevent unnecessary pressure drop and energy loss, ensure that the extra restriction is no higher than is necessary in order for the pressure difference to stop at 20 Pa.

Pressure balancing, of units with connection to the top above filter, must be done with a duct mounted damper with manual level actuator. Same procedure as above can be followed, where the damper is turned to more closed position to create additional air restriction.

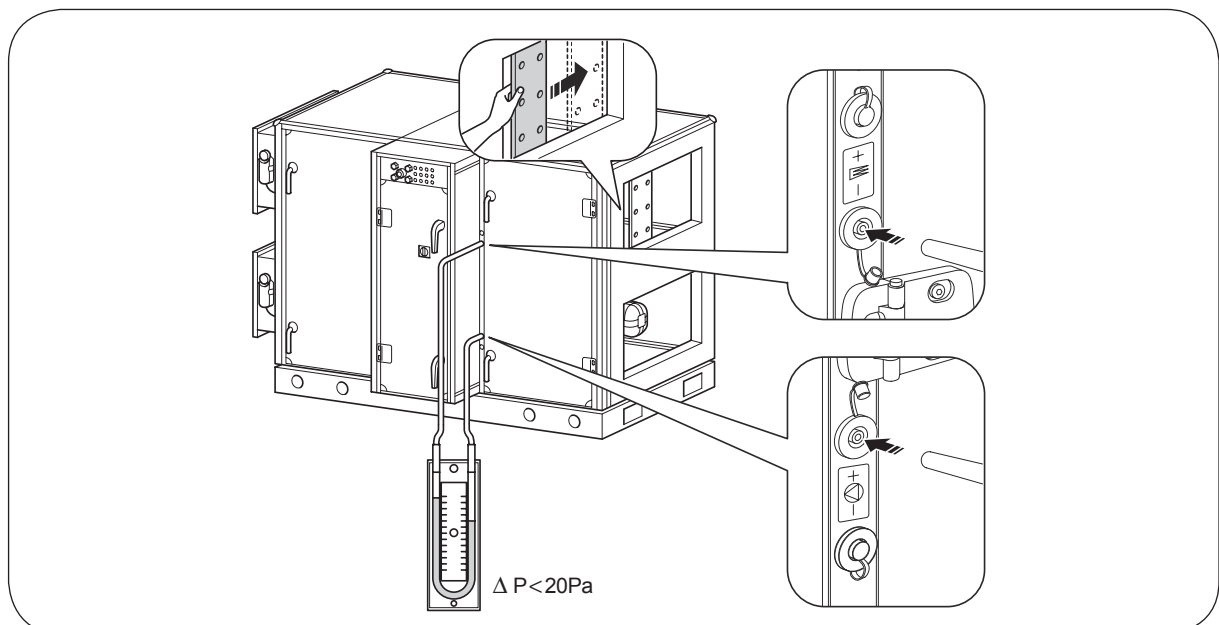

Handheld terminal

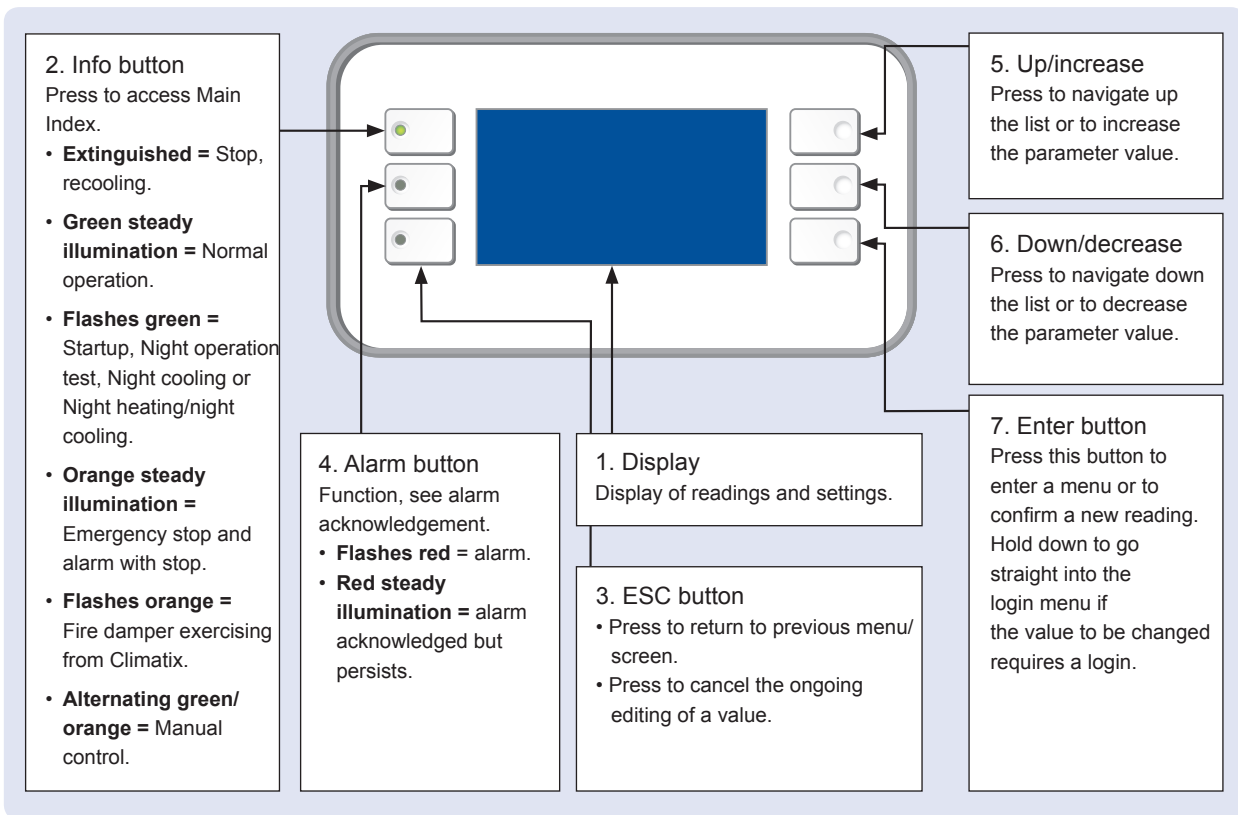

Navigation

Use the up and down buttons (5, 6) to navigate in the handheld terminal. Press one of these buttons to move the cursor up or down to the desired row. To go into the sub-menu, press Enter (7). To go back to the previous menu, press ESC (3).

Changing a value

Place the cursor on the desired parameter using the up and down buttons (5, 6) Then press Enter (7). Set the desired value using the up and down buttons (5, 6). Confirm the change by re-pressing Enter (7). To abandon the change and return to the menu without confirming, press ESC (3).

Please note: From now on in this document, navigation to a sub-menu will be illustrated with the symbol →.

Navigation example

The following example shows how to put the control unit into Auto, i.e. enable operation from the internal schedulers.

1. Place the cursor on the Main index row using the up and down buttons (5, 6).
2. Then press Enter (7) once to show the next level in the menu structure.
3. Move the cursor to the Unit row using the up and down buttons (5, 6).
4. Then press Enter (7) once to show the next level in the menu structure.
5. Move the cursor to the Operating mode row using the up and down buttons (5, 6).
6. Then press Enter (7) once to show the next level in the menu structure.
7. Move the cursor to the Manual operation row using the up and down buttons (5, 6).
8. Press Enter (7) to start editing the value.
9. Change the value to Auto using the up and down buttons (5, 6).
10. Confirm the selection by re-pressing Enter (7).
11. Press ESC (3) three times to return to the Start page.

Overview of the menu structure

The menu structure depends on which functions have been ordered. As a result, it may deviate from this overview. All functions can be accessed by using this overview.

Menu heading	Note
Start page	First menu when switching on the power. Displays operating mode, mode switches and actual values for temperatures.
Log in	Password: 2000.
Main index	
Unit	
Main overview	All actual values and setpoints along with control signals and status.
Inputs	Status: Analogue and digital inputs. Alarm status.
Outputs	Status: Analogue and digital outputs.
Operating mode	
Time switch program	Setting of scheduler.
Night cooling	Settings for free cooling outside operation.
Unoccupied mode	Settings for unoccupied mode heating and unoccupied mode cooling.
Boost	Boost settings.
Setpoints/setting	Setpoints for fan control.
Damper control	Damper status and time constants.
Balance control	Settings for pressure balancing
Fan control	
Supply air fan	Supply air fan status and settings.
Extract air fan	Extract air fan status and settings.
Summer compensation fans	Summer setpoint compensation of fans.
Winter compensation fans	Winter setpoint compensation of fans.
Temperature control	
Setpoints	Setpoint and dead zones for the temperature controller.
Cascade controller	Controller settings for cascade control.
Hrec damper	Heat recovery damper for active mixing status and settings
Crec damper	Cooling recovery damper for active mixing status and settings
Heat recovery	Heat recovery status and settings.
Heating	Heater status and settings.
Electric heaters	Electric heater status and settings.
Cooling	Cooler status and settings
Extra heating	Preheater status and settings.
ReCooler	ReCooler status and settings.
Humidity control	Humidity control and settings.
Air quality control	Air quality control status and settings.
Auxiliary	Various auxiliary functions such as operational status indication.
Controllers	Status and settings of relevant controllers.
Operating period	Measured operating period and reset of runtime meter.
General functions	
Summer and winter changeover	Time and temperature settings when summer starts.
Alarm management	Alarm resetting and alarm outputs.
System overview	Time, language, software information, save/reset settings, communication.
System settings	HMI, password management, diagnostics.
Configuration	
Configuration 1	General functions, accessories and sensors.
Configuration 2	Selection of functions and accessories.
Config. Inputs and outputs	Allocation of physical input and output signals.
Main overview	Shortcut to the operating information menu.

The following pages in this document describe the main functions that may be needed for commissioning and operation.

Start page/Main overview

Start page

When the handheld terminal is energized, the **Start page** will appear. You can easily reach the **Start page** with the INFO button (2). When INFO (2) is pressed, the **Start page** and the **Main index** will appear on alternate presses.

Logging in

To log in, select “**Log in**” on the **Start page**.

START PAGE → LOG IN

The password is **2000**

Tip: You can easily reach the login page from any page in the menu structure by holding Enter (7) pressed for about 2 seconds.

Manual operation

To start or stop the unit manually, or to activate operation via the schedulers (“Auto”), select “**Manual operation**” from the **Start page**.

START PAGE → MANUAL OPERATION

i	Start page		▲
	Log in		
	Main index		
🔔	Main overview		▼
	Manual operation	Off	
	Act operating mode	Off	
🔒	Outside air temp	11.5 °C	✓
	Supply air temp	20.7 °C	
	Act room tmp	22.6 °C	
	Exhaust air temp	22.9 °C	

Main overview

The **Main overview** menu shows a general operating status for the unit's operating system.

Setpoints, actual values, control signals, status of fans, output signals to heating, cooling, heat exchanger etc., can be read off here. Exactly which values are shown will depend on the current configuration.

START PAGE → MAIN OVERVIEW

You can also reach **Main overview** from the Main index.

MAIN INDEX → UNIT → MAIN OVERVIEW

i	Main overview		▲
	Act operating mode	Off	
	Time switch program	Comf St1	
🔔	Outside air temp	11.5 °C	▼
	Room temperature	22.6 °C	
	Exhaust air temp	22.9 °C	
🔒	Supply air temp	20.7 °C	✓
	Outs air damper cmd	Off	
	Act fan step	Off	
	Act sply fan stpt	0 l/s	
	Act sply fan value	0 l/s	
	Supply fan	0%	
	Act exh fan stpt		
	Act exh fan value		

Main index/System overview

Main index

Most functions in the control unit can be accessed from the **Main index**. When INFO (2) is pressed, the **Main index** and the Start page will appear on alternate presses.

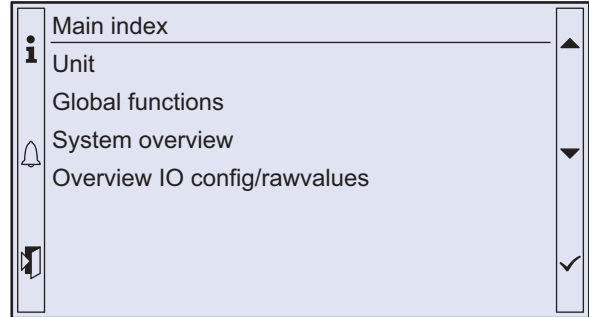

System overview

Date and Time

To change the **date** and **time**, go to:

MAIN INDEX → SYSTEM OVERVIEW

Value	Details
date	DD.MM.YYYY
time	hh:mm:ss

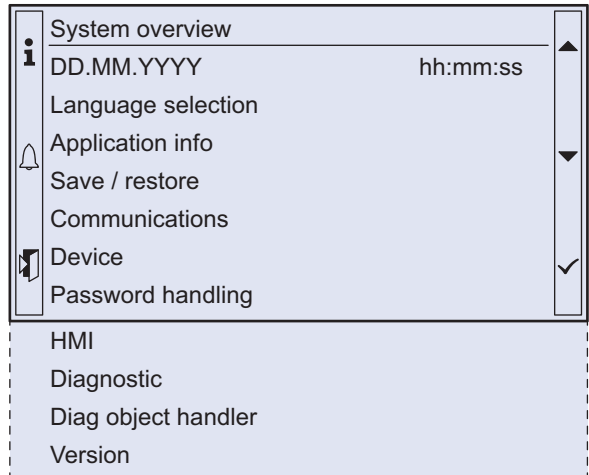

Language

To change the **language**, go to:

MAIN INDEX → SYSTEM OVERVIEW → LANGUAGE SELECTION

And change the parameter "HMI language".

Main index/System overview

Application info

The **Application info** menu shows the software version, order number, sub-number and the date when the control unit was factory-configured. Here you can also enter the name of the application, address and city. Go to:

MAIN INDEX → SYSTEM OVERVIEW →
APPLICATION INFO →
SETTINGS

Place the cursor on the desired information row and press Enter to make the change.

The screenshot shows a menu titled "Application info" with a vertical list of items. The items are: "Fläkt Woods", "eQ fan v2.23.14", "2013-04-22", "12345678/009", "Name", "Street", and "City". Each item has a small icon to its left: an 'i' for the first, a bell for the second, and a document for the third. To the right of the list is a vertical scrollbar. Below the list is a dashed box labeled "Settings".

Explanation

Menu heading
Unit manufacturer
Soft version
Date of factory setting
Order number/sub-number
AHU name
Street address
City
Row for changing the above information

Air handling unit

Air handling unit

Most of the control settings are located in the **Unit** menu. This menu also contains Main overview, see previous page of this document.

MAIN INDEX → UNIT

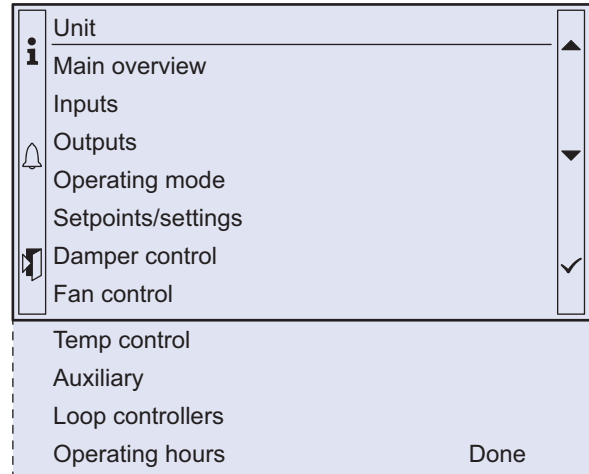

Inputs

This menu shows detailed information from all activated **inputs**, divided by function, and also contains setting options for threshold values, input filters and alarm delay.

MAIN INDEX → UNIT → INPUTS

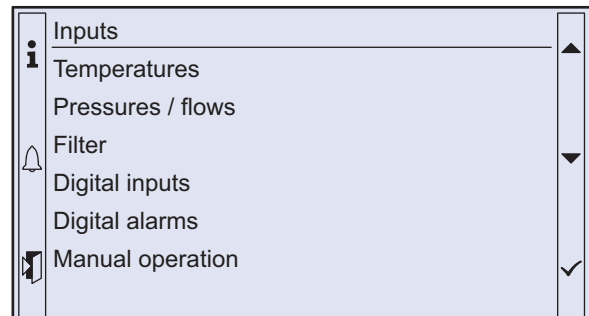

Filter

eQ PRIME is supplied with combined differential pressure sensors for filter monitoring and air flow measurement. Although the sensors are factory calibrated, alarm limits must be checked and, if necessary, adjusted when commissioning. Each **filter** is monitored with both a pre-alarm and an alarm. A pre-alarm is a Class C alarm that can be acknowledged even if the filter pressure is above the alarm limit.

Alarm limit settings

The **alarm limit** for the alarm and pre-alarm can easily be adjusted.

MAIN INDEX → UNIT → INPUTS → FILTER

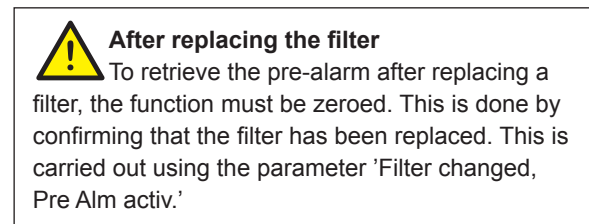

The final pressure drop for the filter is normally set at double the starting pressure drop at the operating point, but at a maximum of 200 Pa. If the pressure drop is to include a prefilter, the maximum is 400 Pa.

Air handling unit

Fire protection unit

If a **fire protection unit** is to be connected, it may be necessary to adjust the parameters. The control unit in eQ PRIME supports connection of the following signals:

- Fire alarm
- Unit shutdown (damper exercise)
- Alarm from fire protection unit

Different signals can be connected depending on the type of **fire protection unit** used. The table below shows available signals and their connection to eQ PRIME.

Fire protection unit	Fire alarm	Alarm from fire protection unit	Unit shutdown
ABAV-S3	73-74	69-70	N/A
FCMA-2	73-74	69-70	71-72
FICO-128	73-74	69-70	71-72

Fire protection unit with eQ Prime bypass

eQ PRIME with bypass and separate fire modes, can distinguish fire alarm in supply air and extract air. For this, separate fire protection units in supply air and extract air is needed.

See table below for connection to eQ:

Fire protection unit	Fire alarm	Alarm from fire protection unit	Unit shutdown
ABAV-S3 for supply air detector	127-128	69-70	N/A
ABAV-S3 for extract/room air detector	73-74	69-70	N/A
FCMA-2 for supply air detector	127-128	69-70	71-72
FCMA-2 for extract/room air detector	73-74	69-70	71-72
FICO-128 for supply air detector	127-128	69-70	71-72
FICO-128 for extract/room air detector	73-74	69-70	71-72

Fire alarm

The **fire alarm** is factory-configured to NC, but a bracket on the terminal block prevents the alarm from going off when there is no extinguishing equipment. The contact function or alarm delay can easily be changed from the menu.

MAIN INDEX → UNIT →
INPUTS → DIGITAL ALARMS → FIRE

Fire alarm mode

For each fire input, it is possible to select a fire mode.

Parameter	Description
InActv	The fire mode is inactive
Stop	The unit will stop
Run Sply	The supply fan will run in fix speed and the exhaust fan will stop
Run Exh	The exhaust fan will run in fix speed and the supply fan will stop
Run Both	Both fan will run in fixed speed
Ctrl St1	The fans will keep to run to fan setpoint Step 1
Ctrl St2	The fans will keep to run to fan setpoint Step 2

Alarm from fire protection unit

To receive a B alarm from the **fire protection unit**, e.g. for an internal error, a digital or universal input must be reconfigured on the control unit. If both the external schedulers are not used, the function of one of them can be changed, e.g. digital input 3 (D3). The process is described below.

1. Log in as administrator (password 8888)
2. Go to MAIN INDEX → UNIT → CONFIGURATION → CONFIGURATION 1
3. Change EXT. CONTROL INPUT to ONE
4. Go to MAIN INDEX → UNIT → CONFIGURATION → CONFIGURATION 2
5. Change AUXILIARY INPUT to ALARM
6. Change RESTART to EXECUTE
7. Log in as administrator (password 8888)
8. Go to MAIN INDEX → UNIT → CONFIGURATION → CONFIGURATION IO's → DIGITAL ALARMS
9. Change AUX. ALARM to DI3
10. Go back to MAIN INDEX → UNIT → CONFIGURATION → CONFIGURATION IO's
11. Change RESTART to EXECUTE
12. Log in as usual (password 2000)
13. Go to MAIN INDEX → UNIT → AUXILIARY → ALARM INPUT and set the desired CONTACT FUNCTION

Note that external control input 1 will now control against the fan step indicated by the parameter Fan Step, see page 22.

Do not hesitate to contact Fläkt Woods support for advice or help with configuration. Tel. +46 36 193003.

Air handling unit

Unit shutdown

The external stop signal (e.g. for fire damper exercising) is factory set to NO. The contact function can easily be changed from the menu.

MAIN INDEX → UNIT →
INPUTS → DIGITAL INPUTS →
EMERGENCY STOP

Bypass

The bypass damper shall be controlled by external fire controller. The air handling unit fans can be configured to handle higher temperatures for shorter times by activating Fire mode. For the EC-motor no activation is needed.

To activate this fire mode in the inverter(Danfoss) go to

MAIN INDEX → UNIT →
FAN CONTROL → FIREMODE, DANFOSS

When function Fire mode is activated the fan operation are not reduced by high temperature or stopped by internal alarms.

Note: If the inverter is damaged in this mode the warranty ceases to apply.

Settings for operation and fan speed can be set in the Fan control menu:

MAIN INDEX → UNIT → FAN CONTROL

Fan speed when activating the digital fire input 1 for fire/smoke in the extract air:

Supply fan fire setpoint 1 default value 80 %
Exhaust fan fire setpoint 1 default value 80 %

Fan speed when activating the digital fire input 2 for fire/smoke in the supply air:

Supply fan fire setpoint 2 default value 0 %
Exhaust fan fire setpoint 2 default value 0 %

Fan control		
Supply fan	off	▶
Exhaust fan	off	▶
Actual step	off	▶
Firemode, Danfoss	yes	▶
Fire mode 1	Run Both	▶
Supl.Fan fire setp.1	80 %	▶ ✓
Exh.Fan fire setp.1	80 %	▶
Fire mode 2	Run Both	▶
Supl.Fan fire setp.2	0 %	▶
Exh.Fan fire setp.2	0 %	▶
Rundown time el htg	180 sec	▶
Disable high speed	-40.0 °C	▶
Op hours settings		▶
Fan override	Auto	▶
Flow control, unit	1/s	▶

Air handling unit

Unit shutdown

The external stop signal (e.g. for fire damper exercising) is factory set to NO. The contact function can easily be changed from the menu.

MAIN INDEX → UNIT →
INPUTS → DIGITAL INPUTS →
EMERGENCY STOP

Manual operation

From the **Manual operation** menu, the inputs on the control unit can be overridden to the desired value. This can be used to simulate various operating conditions, e.g. during commissioning. Go to Change settings under the relevant sensor. Set the parameter Out of service to Active. The Present value can then be set as desired. Remember to restore the parameter Out of service to Passive to obtain correct measured values again.

Outputs

For detailed information, threshold values, etc. about all the activated **outputs**, go to:

MAIN INDEX → UNIT →
OUTPUTS

In the Manual operation menu, the **outputs** on the control unit can be overridden with the desired value. This can be used to simulate various operating conditions. To override an **output**, go to the relevant **output** and change the parameter Manual operation to the desired value. If changing an analogue output, the parameter Manual operation must be changed to Passive before the desired value can be set.

Tip:

Manual operation can be used during commissioning to simulate various operating conditions.

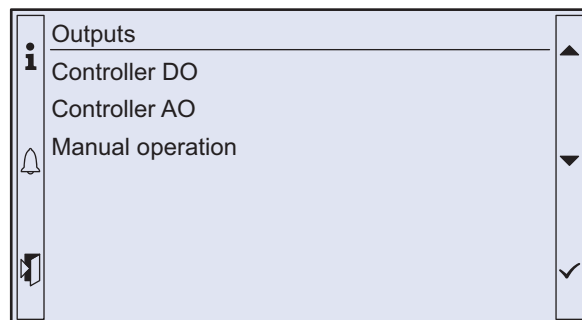

Air handling unit

Operating mode

From the **Operating mode** menu, you can select settings for both internal and external schedulers as well as for other functions that affect operation, such as night cooling and unoccupied mode. The first row shows the activated operating mode.

MAIN INDEX → UNIT →
OPERATING MODE

Operating mode		
Actual	Stop	▲
Manual operation	Off	
Time switch program	Comf St1	▼
From BMS	Auto	
External control	Auto	
Night cooling		
Tmp start		✓
Operating hours		10 sec

Manual operation

To start and stop the unit manually, and to activate operation via schedulers, select **Manual operation** and set the desired value.

MAIN INDEX → UNIT →
OPERATING MODE →
MANUAL OPERATION

Week program

The operating sequence is set for each day of the week in the Schedule menu. Six switchover times can be used per weekday. Time 1 ... 6. Unused switchover times must be set to passive (*.*).

MAIN INDEX → UNIT →
OPERATING MODE →
TIME SWITCH PROGRAM → SCHEDULE

Time switch program

The control unit has three types of internal schedulers: Schedule, Calendar exception and Calendar fix off. Normally, the Schedule is first programmed according to the various preferences for each day of the week.

After this, Calendar exception and Calendar fix off are used to enter exception periods such as weekends, holidays or times when the air handling unit should be shut down.

The internal schedulers are configured from the Time switch program menu, but can be overridden with the parameter Manual operation. For operation via the Scheduler program, Manual operation should be set to Auto.

MAIN INDEX → UNIT →
OPERATING MODE →
TIME SWITCH PROGRAM

Operating mode

Eco St1	Temperature setpoint economy and fan setpoint 1
Comf St1	Temperature setpoint comfort and fan setpoint 1
Eco St2	Temperature setpoint economy and fan setpoint 2
Comf St2	Temperature setpoint comfort and fan setpoint 2
Off	Unit stopped

Tip:

The function Copy schedule can be used if the Monday operating specifications are also to be used for Tuesday to Friday.

Air handling unit

Example

Assume that you want to set the control unit so that the unit starts at 08:00 on Mondays for comfort operation with fan setpoint 2 and then resumes comfort operation with fan setpoint 1 at 12:00, then resumes comfort operation with fan setpoint 2 at 14:00 and shuts down at 18:00.

The correct configuration for this specification is shown to the right.

Please note: If you do not want the unit to start at midnight, Value 1 must be set to Off. Time 1 is locked until 00:00.

Calendar exceptions

In addition to the weekly plan, you can set dates, intervals and days of the week during the year in which you want to employ other operating modes or stop the unit. This is done by means of Calendar exception and Calendar fix off. For operation via **calendar exceptions**, use the following operating mode:

MAIN INDEX → UNIT →
 OPERATING MODE →
 TIME SWITCH PROGRAM → SCHEDULE →
 EXCEPTION

Monday	
Day schedule	Passive
Time 1	00:00
Value 1	Off
Time 2	08:00
Value 2	Comf St2
Time 3	12:00
Value 3	Comf St1
Time 4	14:00
Value 4	Comf St2
Time 5	18:00
Value 5	Off
Time 6	* :*
Value 6	Off

Air handling unit

External schedulers

The eQ PRIME can be supplied with a timer, push button, CO₂ monitor and motion detector to activate extended or forced operation. The control unit can handle up to two external schedulers. On delivery, input 1 is available on terminal block 47-48 and input 2 is available on terminal block 69-70.

The settings are set in the **External control** menu.

MAIN INDEX → UNIT →
OPERATING MODE →
EXTERNAL CONTROL

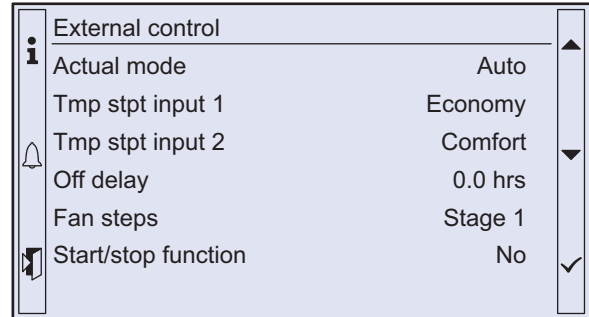

The actual operating mode (Actual mode) is shown on the first row under the heading in this menu. The parameters Tmp stpt input 1 and Tmp stpt input 2 determine the temperature setpoints (Economy or Comfort) that will apply for each digital input.

When input 1 is activated, the fans regulate towards step 1. When input 2 is activated, they regulate towards step 2.

The parameter Fan steps is used to select the setpoints towards which the fans are to regulate when both the external schedulers are activated.

If the external signal remains in place after activation, the timer function (Off delay) in the control unit should be set to 0.0 hrs. In other cases, the desired time should be set directly in the control unit.

If a push button is used, it may be useful to have the option of interrupting the switch-off delay with the push button. This function is obtained if the parameter Start/stop function is set to Yes. In this case, alternate pulses on the inputs will start or stop/reset the timer.

Function	Time
Timer	0.0 hours
Push button	Desired time
CO ₂ monitor	0.0 hours
Occupancy detector	0.0 hours

Occupancy detector

Remember to set the desired operating period directly in the occupancy detector (see figure).

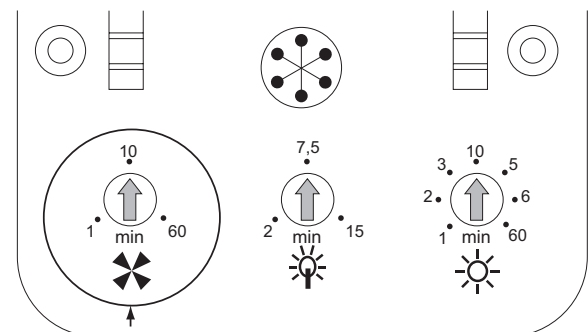

Set the delay setting (10/60 min.) using the potentiometer on the far left as shown in the figure.

Air handling unit

Night cooling

The **night cooling** setting is used during the summer, outside ordinary operating periods, to cool the premises at night with cool outdoor air.

Function: When both the room temperature and outdoor temperature exceed the set threshold value and the difference between these threshold values exceeds the set differential, the air handling unit is started in order to cool the premises using fresh outdoor air. Coolers are disabled. If the unit was ordered with **night cooling**, a facade sensor and a room temperature sensor are included.

Night cooling is activated when:

- Outdoor temperature is higher than Min outs tmp.
- Outdoor temperature < Room temperature - Delta.
- Room temperature > Room tmp setpoint + Hysteresis.

Night purging is disabled when:

- The function has been operating for longer than the Min. operating time.
- External control is activated.
- Outdoor air temperature > Room temperature -1 °C.
- Room temp ≤ Room tmp setpoint.

To retrofit the unit with night purging, contact Fläkt Woods support (+46 36 193003).

Night cooling	
Room tmp setpoint	22.0 °C
Hysteresis	3.0 °C
Delta	5.0 °C
Min outs tmp	12.0 °C
Min run time	30.0 min

Air handling unit

Tmp start

Night temp. start prevents the building from cooling down or heating up excessively at night outside normal operating times. This is controlled via a separate setpoint for heating and cooling.

Function: The air handling unit starts at full power from the air heater or air cooler if the room temperature drops below or rises above the set value.

If the unit was ordered with night heating, a room temperature sensor is always included.

Ttmp start		
i	Start stpt cooling	30.0 °C ▲
	Cooling setpoint	15.0 °C
🔔	Start stpt heating	15.0 °C ▼
	Heating setpoint	30.0 °C
	Hysteresis	1.0 °C
🔕	Minimum off time	30 min ✓
	Min run time	0.0 min

Ttmp start cooling is activated when

- Room temperature > Start stpt cooling.
- The Minimum off time has expired since unoccupied mode was most recently activated. Temperature control is done with Cooling setpoint.

Ttmp start cooling is deactivated when

- Room temperature < Start stpt cooling – Hysteresis.
- The Min run time has expired since Ttmp start cooling was activated.

Ttmp start heating (night heating) is activated when

- Room temperature < Start stpt heating.
- The Minimum off time has expired since unoccupied mode was most recently activated. Temperature control is done with Heating setpoint.

Ttmp start heating (night heating) is deactivated when

- Room temperature > Start stpt heating + Hysteresis.
- The Min run time has expired since Ttmp start heating was activated.

To retrofit the unit with Ttmp start, or to change the extract air fan and damper function, contact Fläkt Woods support on (+46 36 193003).

Air handling unit

Boost

Boost is a function that ensures comfortable room temperature when the unit is started normally via internal schedulers. This function is not activated from the factory, but can easily be activated on site. See page 38.

MAIN INDEX → CONFIGURATION →
CONFIGURATION 2 → BOOST

Optimised start of heating and cooling is activated separately.

Optimised start of cooling is activated when:

- Room temperature > Start stpt cooling + Hysteresis.
- The time until start via internal schedulers < Compensation time.

Optimised start of cooling is deactivated when:

- Room temperature < Start stpt cooling.

Optimised start of heating is activated when:

- Room temperature < Start stpt heating + Hysteresis.
- The time until start via internal schedulers < Compensation time.

Optimised start of heating is deactivated when:

- Room temperature > Start stpt heating.

If the function is activated without the room temperature sensor connected, the measured value from the air temperature sensor will be used instead. This function is always included in eQ PRIME.

Boost	
Start stpt cooling	15.0 °C
Start stpt heating	25.0 °C
Hysteresis	0.5 °C
Compensation time	60 min

Air handling unit

Main setpoints

To set the desired **Main setpoints** for temperature and fans, go to:

MAIN INDEX → UNIT →
SETPOINTS/ SETTINGS

This menu shows the **Main setpoints** for temperature and fans. Go to All settings to access the settings for sub-level functions. The content of this menu is changed according to the selected temperature and fan control settings. The active operating mode from the internal schedulers is shown directly under All settings.

Temperature setpoints

- Heating setpoint for comfort operation (Comfort htg stpt)
- Heating setpoint for economy operation (Economy htg stpt)
- Dead zone between heating and cooling during comfort operation (Comfort tmp deadz)
- Dead zone between heating and cooling during economy operation (Economy tmp deadz)
- Lowest permitted supply air temperature (Supply tmp min stpt)
- Highest permitted supply air temperature (Supply tmp max stpt)

Note: Cooling setpoint = Heating setpoint + dead zone.

Fan setpoints

- Setpoint supply air fan step 1 (Sply fan st1 stpt)
- Setpoint supply air fan step 2 (Sply fan st2 stpt)
- Setpoint extract air fan step 1 (Exh fan st1 stpt)
- Setpoint extract air fan step 2 (Exh fan st2 stpt)

Note: Fan setpoints are given in either l/s or Pa, depending on the activated control function.

Important!

Remember that electric heaters require at least one minimum air flow value.

Refer to the minimum flows in the table on the next page.

Main setpoints	
All settings	Comf St1
Comfort htg stpt	22.0 °C
Comfort tmp deadz	22.0 °C
Comfort htg stpt	22.0 °C
Economy tmp deadz	22.0 °C
Supply tmp min stpt	22.0 °C
Supply tmp max stpt	22.0 °C
Sply fan st1 stpt	250l/s
Sply fan st2 stpt	600l/s
Exh fan st1 stpt	250l/s
Exh fan st2 stpt	600l/s

Air handling unit

Minimum flows for duct-mounted electric heaters

Connection Ø/WxH	Output, kW Variant 1	Min. flow m ³ /s
Ø315	3	0.12
Ø400 ¹	5	0.19 (0.24 ¹)
Ø500 ²	12	0.37
800x400	12	0.48
1100x500	17	0.82
1400x600	20	1.3
1400x800	30	1.7

Connection Ø/WxH	Output, kW Variant 2	Min. flow m ³ /s
Ø315	5	0.12
Ø400 ¹	9	0.19 (0.24 ¹)
Ø500 ²	17	0.37
800x400	17	0.48
1100x500	30	0.82
1400x600	34	1.3
1400x800	48	1.7

Connection Ø/WxH	Output, kW Variant 3	Min. flow m ³ /s
Ø315	9	0.12
Ø400 ¹	15	0.19 (0.24 ¹)
Ø500 ²	24	0.37
800x400	24	0.48
1100x500	43	0.82
1400x600	54	1.3
1400x800	75	1.7

- 1 Rectangular air heater (400x400) with a circular connection for output variant 3 (15 kW)
- 2 Rectangular air heater (500x500) with circular connection, all output variants.

Minimum flows for air handling unit-mounted electric heaters

Unit size aaa	Min. flow m ³ /s
005	0.27
008	0.50
011	0.7
018	1.1
023	1.6
032	1.9
041	2.4
050	3.2

Air handling unit

Fan control

All the necessary fan settings can be set from the **Fan control** menu.

MAIN INDEX → UNIT →
FAN CONTROL →

This menu includes settings for:

- Alarm for deviation from fan setpoint
- Fire protection function
- Rundown of electric heater
- Disabling of fan step 1 at low outdoor temperatures
- Operating hours alarm

Fan control		
Supply fan	Off	▲
Exhaust fan	Off	
Act fan step	Off	▼
Fire mode	Stop	
Fire setpoint	80%	
Rundown time el htg	180 sec	✓
Disable high speed	-40.0 °C	
Summer comp	0.0%	
Winter comp	0.0%	
Op hours settings		

Deviation alarm

The **Deviation alarm** monitors the unit's ability to keep to the configured fan setpoints. The supply and extract air fans are set separately.

Supply air fan

MAIN INDEX → UNIT →
FAN CONTROL → SUPPLY FAN →
SETPOINTS/ SETTINGS →
DEVIATION ALARM

Extract air fan

MAIN INDEX → UNIT →
FAN CONTROL → EXHAUST FAN →
SETPOINTS/ SETTINGS →
DEVIATION ALARM

Deviation alarm		
Alarm	Passive	▲
Min limit	20 l/s	
Maximum deviation	300 l/s	▼
Start up delay	180 sec	
		✓

Settings

- The lowest permitted value for feedback signal, i.e. flow or pressure (Min limit).
- Maximum permitted deviation from fan setpoint (Maximum deviation).
- Alarm delay during startup (Start up delay).

Bear in mind that there is often a simple explanation why the **deviation alarm** is triggered. For troubleshooting tips, see Questions and answers on page 48.

Air handling unit

Fire mode

The control unit in eQ PRIME can be configured for various **Fire modes**, i.e. how the fans are controlled in the event of a fire alarm. For possible choices, see below and on the next page.

MAIN INDEX → UNIT →
FAN CONTROL → FIRE MODE

The fire setpoint value refers to a constant control signal linked to one or both fans as indicated above. The value is entered in the control unit as a percentage (0...100 %) of the maximum control signal. Note that the same control signal is linked to both fans if the control unit is configured so that both fans are controlled towards the fire setpoint.

MAIN INDEX → UNIT →
FAN CONTROL → FIRE SETPOINT

Rundown

If the control unit has been configured for a electrical heater, **rundown** will occur before the unit stops.

Rundown is factory-set to 3 minutes, but this can easily be changed with the following parameters:

MAIN INDEX → UNIT →
FAN CONTROL → RUNDOWN TIME EL HTG

Fan control		
Supply fan	Off	▲
Exhaust fan	Off	
Act fan step	Off	▼
Fire mode	Stop	
Fire setpoint	80%	
Rundown time el htg	180 sec	✓
Disable high speed	-40.0 °C	
Summer comp		0.0%
Winter comp		0.0%
Op hours settings		

Fire mode	Explanation
Stop	Both fans off.
Run Sply	Supply air fans are controlled towards the fire setpoint. Extract air fan stopped.
Run Exh	The extract air fan is controlled towards the fire setpoint. Supply air fan stopped.
Run Both	Both fans are controlled towards the fire setpoint.
Ctrl St1	Both fans regulate towards the fan setpoints in step 1.
Ctrl St2	Both fans regulate towards the fan setpoints in step 2.

Disable high speed

To reduce the risk of heat loss, the control unit can be configured to **disable** Fan stage 1 at low outdoor temperatures. The desired threshold value is set with the following parameters:

MAIN INDEX → UNIT →
FAN CONTROL → DISABLE HIGH SPEED

Remember to also set Fan stage 2 when this function is used.



Air handling unit

Outdoor temperature compensation fan setpoints

This function adjusts the fan setpoints up or down according to the outdoor temperature. This is done by means of break points in the Summer comp and Winter comp menus, which are accessed via the Fan control menu.

MAIN INDEX → UNIT → FAN CONTROL

Fan control		
Supply fan	Off	▲
Exhaust fan	Off	
Act fan step	Off	▼
Fire mode	Stop	
Fire setpoint	80%	
Rundown time el htg	180 sec	✓
Disable high speed	-40.0 °C	
Summer comp		0.0%
Winter comp		0.0%
Op hours settings		

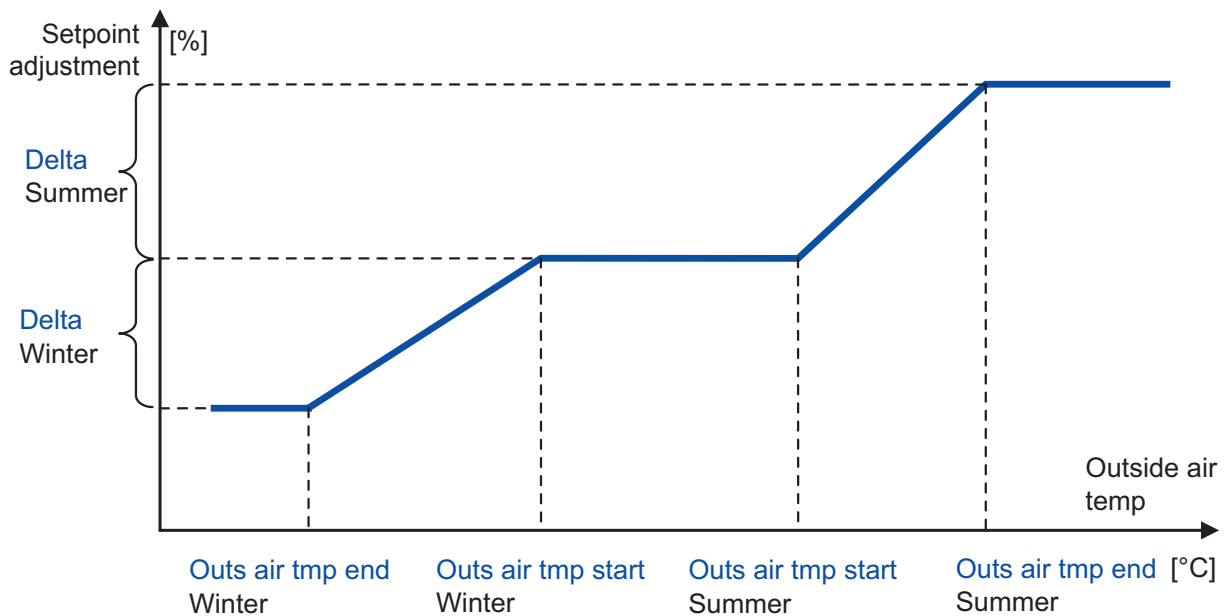

Air handling unit

Summer comp fan

From this menu, fan setpoints can be offset at high outdoor temperatures.

MAIN INDEX → UNIT →
FAN CONTROL → SUMMER COMP

If Delta is negative, the setpoints are lowered. If Delta is positive, the setpoints are raised.

Summer comp fan		
Outs air tmp start	25.0 °C	▲
Outs air tmp end	30.0 °C	
Delta	0.0%	▼
		✓

Winter comp fan

From this menu, fan setpoints can be offset at low outdoor temperatures.

MAIN INDEX → UNIT →
FAN CONTROL → WINTER COMP

If Delta is negative, the setpoints are lowered. If Delta is positive, the setpoints are raised.

Winter comp fan		
Outs air tmp start	5.0 °C	▲
Outs air tmp end	-20.0 °C	
Delta	0.0%	▼
		✓

Air handling unit

Temp control

The **Temp control** menu can be used to select all the necessary temperature settings.

MAIN INDEX → UNIT →
TEMP CONTROL

The actual temperature value, current setpoints and control signals for the functions in the control sequence are shown directly in this menu.

Some of the settings in the sub-menus:

- Temperature setpoints
- Max. and min. supply air temperature
- Weather compensation for temperature setpoints
- Cascade controller settings
- Controller settings
- Alarm settings
- etc.

Temp control		
i	Act controlled tmp	21.9 °C
	Tmp setpoints	
	Cascade controller	22.0 °C 20.0 °C
	Heat recovery	0%
	Heating	0%
	Cooling	0%

Pre heater

A pre heater is used to warm up cold outdoor air before the air enters the AHU. This function is used during periods of low outdoor temperatures to prevent frost from building up in the filter. The pre heater controller operates with a separate set point that is adjustable from the HMI.

MAIN INDEX → UNIT →
TEMP CONTROL → HEATING 2 / EL HEATING 2

El Heating 2		
i	Controller	0 %
	Output signal	0 %
	Command	Off
	Extra Seq setpoint	-5.0 °C
	Alarm	OK
	Start stage 1	20 %
	Stage hys off	10 %
Max limitation fan		

Air handling unit

Weather compensation, temperature

This function adjusts the temperature setpoints up or down according to the outdoor temperature. Increasing the temperature setpoints to compensate for high or low outdoor temperatures improves indoor

comfort in cold winter and hot summer weather. It also saves energy in summer. The setpoints are changed by means of break points in the Summer comp and Winter comp menus, which are accessed via the Temp control menu.

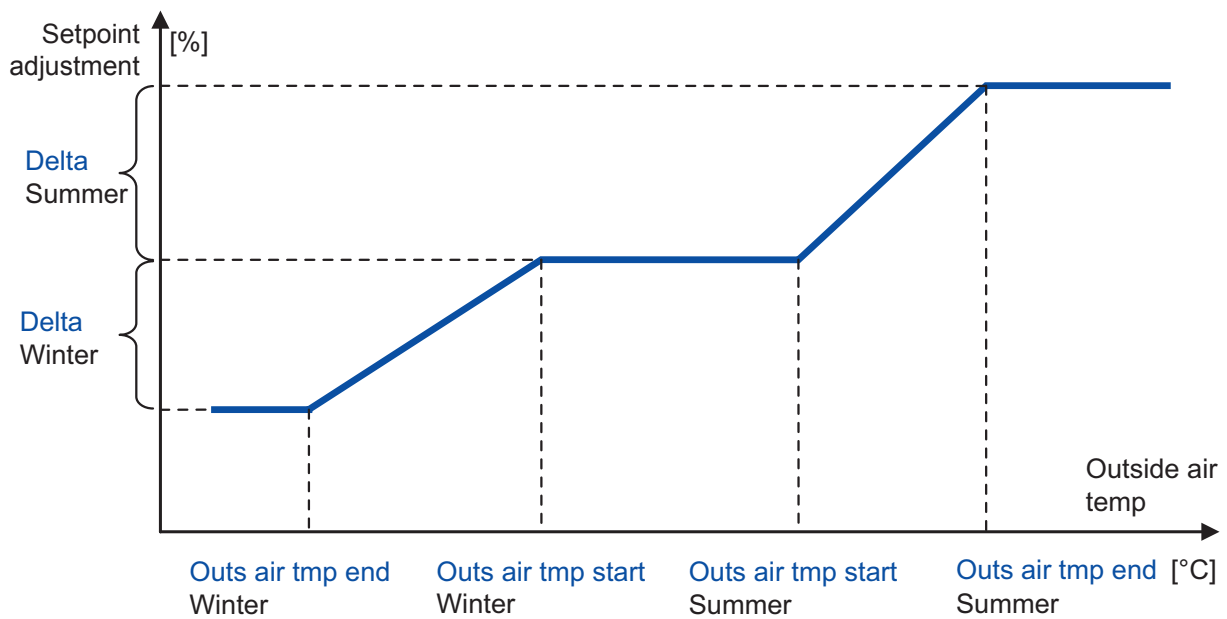

Air handling unit

Humidity control

The controller settings for humidification and dehumidification can be viewed and changed in the **Humidity control** menu.

MAIN INDEX → UNIT →
HUMIDITY CONTROL

Humidification can be disabled during the summer with the parameter Summer disable.

Go to setpoint page with all setpoints related to humidity control.

MAIN INDEX → UNIT →
HUMIDITY CONTROL → SETPOINTS

Humidity control		
Act controlled hum	25.1 %rH	▲
Setpoints		
Max controller spl ...		▼
Humidification	0 %	
Dehumidification	0 %	
Summer disable	No	✓

Hum setpoints		
Act controlled hum		▲
Room	0.0 %rH	
Act dehum stpt	60.0 %rH	▼
Act hum stpt	40.0 %rH	
Act sply dehum stpt	60.0 %rH	
Act sply hum stpt	40.0 %rH	✓
Dehum setpoint	60 %rH	
Hum setpoint	40 %rH	
Sply hum min stpt	30.0 %rH	
Supply hum max stpt	70.0 %rH	
Sply hum dev alarm		
Room hum dev alarm		

9

Control modes

Room	Room/exhaust humidity control only
Supply	Supply humidity control only
Room Cascade	Cascade control of humidity

For room cascade mode, the humidity in the room will set the setpoint in the supply air. Supply air humidity will be limited by a max and min setpoint.

In dehumidification mode, the cooling signal will consist of the maximum value from the cooling controller and the dehumidification controller.

Deviation alarm

It is possible to activate deviation alarm for the humidity. It monitors the unit's ability to keep the humidity setpoints. The room humidity and the supply humidity are set separately.

Supply humidity

MAIN INDEX → UNIT →
HUMIDITY CONTROL → SETPOINTS →
SPLY HUM DEV ALARM

Room humidity

MAIN INDEX → UNIT →
HUMIDITY CONTROL → SETPOINTS →
ROOM HUM DEV ALARM

Air handling unit

Air quality control

Air quality control is available with normal or inverted function. With Normal Function, the fan setpoints are increased proportionally when the carbon dioxide level exceeds the set Setpoint. In this case, the carbon dioxide sensor should be installed in the room or in the extract air. Inverted function is used when a carbon monoxide sensor has been installed in the outdoor air. The fan setpoints are decreased proportionally if the carbon monoxide level exceeds the set Setpoint. The proportional adjustment of the setpoints is equal for both fans.

Air quality control		
Controller	0 %	▲
Function	Normal	
Setpoint	800 ppm	▼
		✓

MAIN INDEX → UNIT →
AIR QUALITY CONTROL

This menu includes settings for Setpoint, choice of Function and Controller. Note that the gain must be negative (measured values higher than the setpoint value must be negatively pressurised).

Active mixing

Active mixing is a flow controlled recirculation.

The function is initialized with minimization of the differential pressure over the mixing damper. This is done with the extract air damper (optimal) and the outdoor damper, depending on the pressure setup of the installation. After that, the mixing damper and the outdoor damper are controlled in parallel for mixing the air. The exhaust fan is controlled to keep the flow balance in the unit.

If full recirculation is allowed the exhaust air fan will stopped and the mixing damper will be fully open.

⚠ 0-calibration

For correct function of the active mixing, the unit must make a 0-calibration when commissioning the unit.

To execute a 0-calibration set the Manual operation to Auto and go to:

MAIN INDEX → UNIT → TEMP CONTROL →
HREC DAMPER → SETTINGS → START

The air handling unit will first run in stable condition in max speed and then in fan setpoint Step 1.

Hrec damper		
Controller	0 %	▶
Output signal	100 %	▶
Recovery value	100 %	▼
Crec damper		
Controller	0 %	▶
Output signal	100 %	▶
Recovery value cooling	100 %	✓
FreshAir		0 %
Limit/settings		
Min fresh air	4 %	▶
Min flow fresh air	14 1/s	▶
Controller, Q-min	0 %	▶
Output signal	0 %	▶
Q-min Out ,signal	0 %	
Settings		▶

Air handling unit

Settings can be done in the Heat recovery damper menu:

MAIN INDEX → UNIT →
TEMP CONTROL → HREC DAMPER

There is a lower limit for the outdoor air flow during mixing in the controller. This limit can be set in several ways.

Parameter	Unit	Description
Min fresh air	%	Limitation of the the mixing controller output value.
Min flow fresh air	l/s	A controller is controlling the minimum amount of outdoor air in l/s to the supply air.
Air quality setpoint	ppm	The air quality setpoint in the room is limiting the active mixing controller output. See page 34 for air quality settings.

Balance control		
Prs.balance setpoint	10 Pa	▶
Force damp. at start	60 sec	▶
Max Bal.control time	60 sec	▶
Max Bal. Prs. deviation	10Pa	▶
Balance Control Exh.	100 %	▶
Pres.balance Exh.damp	0 %	▶
Min. Prs.balance Exh.damp	50 %	▶
Exh.Bal. Contrl. Invert	Active	▶
Balance Control outsideAir	100 %	▶
Pres.balance Outsidedamp	0 %	▶
Min. Prs.balance Outs.damp	50 %	▶
Outs.Bal. Contrl. Invert	Active	▶

Active mixing pressure balancing

The settings for pressure balancing can be found in the Balance control menu:

MAIN INDEX → UNIT →
DAMPER CONTROL → BALANCE CONTROL

Prs.balance setpoint is the setpoint when pressure balancing over mixing damper. When the pressure is within the setpoint as near as the max deviation, Max Bal. Prs. deviation, the mixing damper is starting to open. If the setpoint is not achieved within a time period, Max Bal. control time, the mixing damper is opened.

Air handling unit

Auxiliary

The control unit has various auxiliary functions. These functions are managed from the **Auxiliary** menu.

MAIN INDEX → UNIT →
AUXILIARY

The eQ PRIME is delivered with only the configurable operating mode output activated. For this reason, setting and reading of this function should be done via the **Auxiliary** menu.

This output can be very useful if the unit's operation will affect other equipment.

Do not hesitate to contact Fläkt Woods support for advice and assistance. Tel. +46 36 193003.

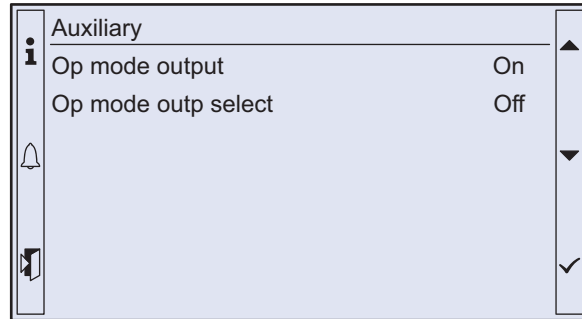

Auxiliary	
Op mode output	On
Op mode outp select	Off

Loop controllers

From the **Loop controllers** menu, you can adjust all the controllers for the control unit.

MAIN INDEX → UNIT →
LOOP CONTROLLERS

This menu contains settings for Gain, integration time constant and derivative time constant. Note that the gain must be negative for cooling but positive for other controllers.

However, the cascade controller settings are different from the other settings. In this case, it is not possible to set the actual PID controller. Instead, High limit and Low limit can be set for the supply air temperature. It is also possible to set Load compensation, which causes constant offsetting of the cascade controller's output signal (i.e. of the calculated supply air setpoints).

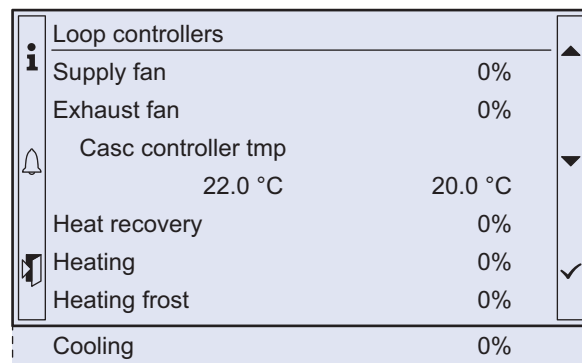

Loop controllers	
Supply fan	0%
Exhaust fan	0%
Casc controller tmp	22.0 °C 20.0 °C
Heat recovery	0%
Heating	0%
Heating frost	0%
Cooling	0%

Air handling unit

Operating hours

The control unit in the eQ PRIME is equipped with operating time meters for fans and circulation pumps. They can be used to signal a need for maintenance, e.g. filter replacement.

MAIN INDEX → UNIT →
OPERATING HOURS

If you want the control unit to emit an alarm signal after the fans have been operating for a certain period, this function must be activated during commissioning.

MAIN INDEX → UNIT →
OPERATING HOURS → FAN SETTINGS

The desired alarm time must be set with a parameter in the same menu.

Operating hours		
Supply fan	0 hrs	▲
Reset	Execute	
Exhaust fan	0 hrs	▼
Reset	Execute	
Fan settings		
Heating pump	0 hrs	✓
Reset	Execute	
Cooling pump	0 hrs	
Reset	Execute	

Alarms

Alarms are indicated by a red LED on the alarm button (4) on the handheld terminal. Press the alarm button once to show the alarm on the display. Press the alarm button once more to show the entire alarm list. Alarms are presented in clear text in the alarm list. Scroll through the alarm list using the up and down buttons (5, 6).

Repeatedly pressing the alarm button causes the alarm menus to circulate in the following order:

ALARM LIST DETAIL → ALARM LIST →
ALARM HISTORY → SETTINGS →
ALARM LIST DETAIL...

Return to the previous menu using the ESC button (3).

Alarm acknowledgement

Acknowledge an alarm by logging in and then pressing the alarm button (4) twice so that "Alarm list" appears on the display.

The "Acknowledge" function is at the top of this page, along with the number of alarms. Place the cursor on this row using the up and down buttons (5, 6). Press the Enter button (7) and select "Active" to acknowledge an alarm. If the alarm persists, the light on the alarm button will shine continuously.

Alarm list		
Acknowledge	2	▲
+ MB comm alarm: Alarm		
+ Exhaust air flow: Alarm		▼
		✓

Air handling unit

Activation/changing of functions

The control unit in the eQ PRIME has powerful standard software that allows functions to be activated, changed or removed retroactively. This is done from the Configuration menu. To access this menu, it is necessary to log in using 8888. Below is a list of the most common changes.

Note that a new sensor may be required after making a change. Do not hesitate to contact Fläkt Woods support for further information, advice or help regarding settings. Tel. +46 36 193003.

It is usually necessary to restart the control unit in order for the changes to be applied. This can be done with a parameter at the bottom of each sub-menu.

Function	Search path (Parameter)	Comment
Weather compensation, temperature (Summer/Winter compensation)	MAIN INDEX → CONFIGURATION → CONFIGURATION 2 → SU/WI COMP TMP	For function description, see page 33.
Outdoor temperature compensation fan setpoints	MAIN INDEX → CONFIGURATION → CONFIGURATION 2 → FAN COMP OUTS TMP .	For function description, see page 30.
Control mode fans	MAIN INDEX → CONFIGURATION → CONFIGURATION 1 → FAN CONTROL MODE	Available choices for eQ PRIME: Fixed speed (Fixed speed) Flow (Flow control) Pressure (Pressure control) SupplySlv (Pressure control extract air, flow control supply air) ExhaustSlv (Pressure control supply air, flow control extract air)
Control mode, temperature	MAIN INDEX → CONFIGURATION → CONFIGURATION 1 → TMP CONTROL MODE	Available choices for eQ PRIME: Supply air (Supply air control) RmSplyC (cascade control, room) ExhSplyC (Cascade control, extract air) RmSplyC Su (Summer room control, winter supply air control) ExSplyC Su (Summer extract air control, winter supply air control) Room (Room temperature control) Extract air (Extract air temperature control) HOTC (Heat exchanger optimised temperature control)
Night cooling	MAIN INDEX → CONFIGURATION → CONFIGURATION 2 → NIGHT COOLING	For function description, see page 23.
Unoccupied mode	MAIN INDEX → CONFIGURATION → CONFIGURATION 2 → TMP START	For function description, see page 24.
Boost	MAIN INDEX → CONFIGURATION → CONFIGURATION 2 → BOOST	For function description, see page 25.

Air handling unit

Cooling recovery	MAIN INDEX → CONFIGURATION → CONFIGURATION 2 → HREC CLG RECOVERY	Start Outdoor temperature > Room temperature + 2K and Room temperature > Room setpoint + 1K Stop Outdoor temperature ≤ Room temperature or Room temperature ≤ Room setpoint
Filter alarm	MAIN INDEX → CONFIGURATION → CONFIGURATION 1 → FILTER ALARM	The filter alarm on the eQ PRIME is always activated at the factory (Supply air-AI+Extract air-AI)
CO ₂ control	MAIN INDEX → CONFIGURATION → CONFIGURATION 2 → FAN COMP AIR QUAL	
IPSUM	MAIN INDEX → CONFIGURATION → INTEGRATIONS → IPSUM SYSTEM	Function: The fan and/or temperature setpoints are controlled to achieve minimum energy consumption by the IPSUM system
Humidity control mode	MAIN INDEX → CONFIGURATION → CONFIGURATION 2 → HUM CONTROL MODE	For control mode function see page 34 [ref to Humidity control].
Humidity control UNIT	MAIN INDEX → CONFIGURATION → CONFIGURATION 2 → HUM CONTROL UNIT	Change between absolute or relative humidity setpoint.
Dehumidity or temperature priority	MAIN INDEX → CONFIGURATION → CONFIGURATION 2 → DEHUM TEMP PRIO	Give the temperature setpoint priority over the humidity setpoint. If heating valve position reaches 90 % it will reduce the dehumidification.
Deviation alarm	MAIN INDEX → CONFIGURATION → CONFIGURATION 2 → HUM DEVIATION ALARM	Activation of humidity deviation alarm.

Air handling unit

Pressure/flow sensor

Differential pressure sensors are supplied as separate accessories when the eQ PRIME has been ordered with pressure control. The flow sensor is always factory-installed (included in multifunction sensor). The settings differ slightly between the pressure and flow sensors.

Duct pressure sensor

Fläkt Woods's **duct pressure sensor** has a settable measuring range. To obtain the best possible measurement signal from the differential pressure sensor, the lowest possible measuring range should be chosen. This setting should be performed for both the sensor and the control unit.

The measuring range for the sensor is set with jumpers. The lowest measuring range (500Pa) is obtained by removing jumpers 1, 2 and 3.

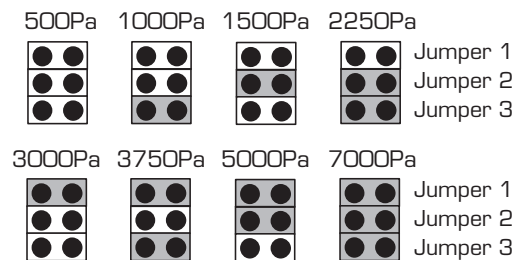

Zero point calibration

NOTE! Zero point calibration must be performed on the sensors during commissioning. They should then be zero calibrated annually.

The sensors should have been energized for approximately one hour before calibration is performed.

Disconnect the pressure hose from the sensor.

To start calibration press the button next to the pressure range jumpers for approximately 4 seconds, until the LED lights up. When the LED goes out again, calibration is complete and the pressure hose can be reconnected.

Response time

The **response time** is also set using the button beside the jumpers. A short press of the button changes the jumpers. A short press of the button changes between 0.8 and 4 seconds. If the LED flashes 3 times after pressing the button, the response time is 0.8 seconds. If it flashes twice, the response time is 4 seconds. For optimum operating stability, a response time of 4 seconds is recommended.

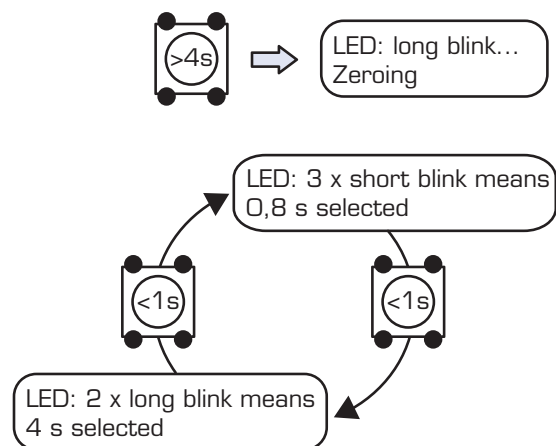

Air handling unit

Control unit

To set the equivalent measuring range in the **control unit**, go to:

MAIN INDEX → UNIT →
OVERVIEW IO CONFIG/RAWVALUES →
PRESSURES/FLOWS

and set the same measuring range as in the sensor for supply air pressure and extract air pressure, respectively.

IO conf press/flows		
HW IO:	Pos: Fact:	Scale:
Supply air pressure	X7	500Pa
Type:		0-10V
Exhaust air press	X8	500Pa
Type:		0-10V
Modbus		
Fact:		

Flow sensor

The **flow sensors** are installed, connected and configured at the factory. For this reason, they normally do not need to be set on site. However, it is still necessary to mention zero point calibration, flow calculation and temperature correction.

Zero point-calibration

Zero point-calibration can be performed, if necessary, by means of a push button placed underneath the sensor cover. Zero point calibration must be performed on sensors subjected to high overpressure.

Flow calculation

The control unit calculates the flow according to the following formula:

$$q = \frac{1}{k} \sqrt{\Delta p} \text{ m}^3/\text{s}$$

In which q is the flow and Δp is the differential pressure from the sensor.

The k factor is shown on the air handling unit data plate and in the control unit's menu.

MAIN INDEX → UNIT →
OVERVIEW IO CONFIG/RAWVALUES →
PRESSURES/FLOWS

IO conf press/flows		
Modbus		
Fact:		
Supply Flow Pressure	22.23	
Present value		0Pa
Return Flow Pressure	22.23	
Present value		0Pa

Temperature correction

The flow scale on the display instrument and flow formula above apply to air at a temperature of +20 °C. At other air temperatures the flow must be corrected using the formula:

$$q = q_{20} \sqrt{\frac{(273+t)}{293}} \text{ m}^3/\text{s}$$

q = the actual flow through the fan,

q_{20} = the flow reading

t = current temperature in °C

ReCooler HP

ReCooler HP

The ReCooler HP is an integrated reversible cooler. Depending if the air handling unit is in heating or cooling demand the ReCooler HP will alter between cooling and heating mode.

Defrost fan compensating

Under some conditions the ReCooler HP will go to a defrost mode during a couple of minute. During this time the fans will go on reduced speed. This reduced fan speed is configurable for each fan. The settings are 20-100 % of actual fan setpoint.

MAIN INDEX → UNIT →
TEMP CONTROL → COOLING

The ReCooler HP status is shown in the eQ display, such as the cooling/ heating demand and the actual operating status. If there is an alarm in the ReCooler HP, it could be viewed in the eQ display.

Cooling		
Controller	0%	▲
Output signal	40%	
Disable by outs tmp	12.0 °C	▼

Act. Opstatus	Stop	
Alarm number	LowEnv.limit	✓

Alarm	Description
No alarm	No alarm
Rotor alarm	Rotor alarm
Comp. alarm	Compressor start alarm
Diff.press alarm	Differential pressure alarm
Max.pressure	Max. Discharge pressure alarm
Inverter alarm	Frequency drive (power+) alarm
Inverter offline	Frequency drive offline alarm
Min.pressure	Min. Suction pressure alarm
EEV fault	Expansion valve alarm (sensor)
Discharge temp	Discharge temperature alarm (sensor)
Discharge press	Discharge pressure alarm (sensor)
Suction pressure	Suction pressure alarm (sensor)
Superheat alarm	Low superheat alarm
High env. limit	High envelope limit (pressure)
Low env. limit	Low envelope limit (pressure)

ReCooler HP

Cooling/heating circuit

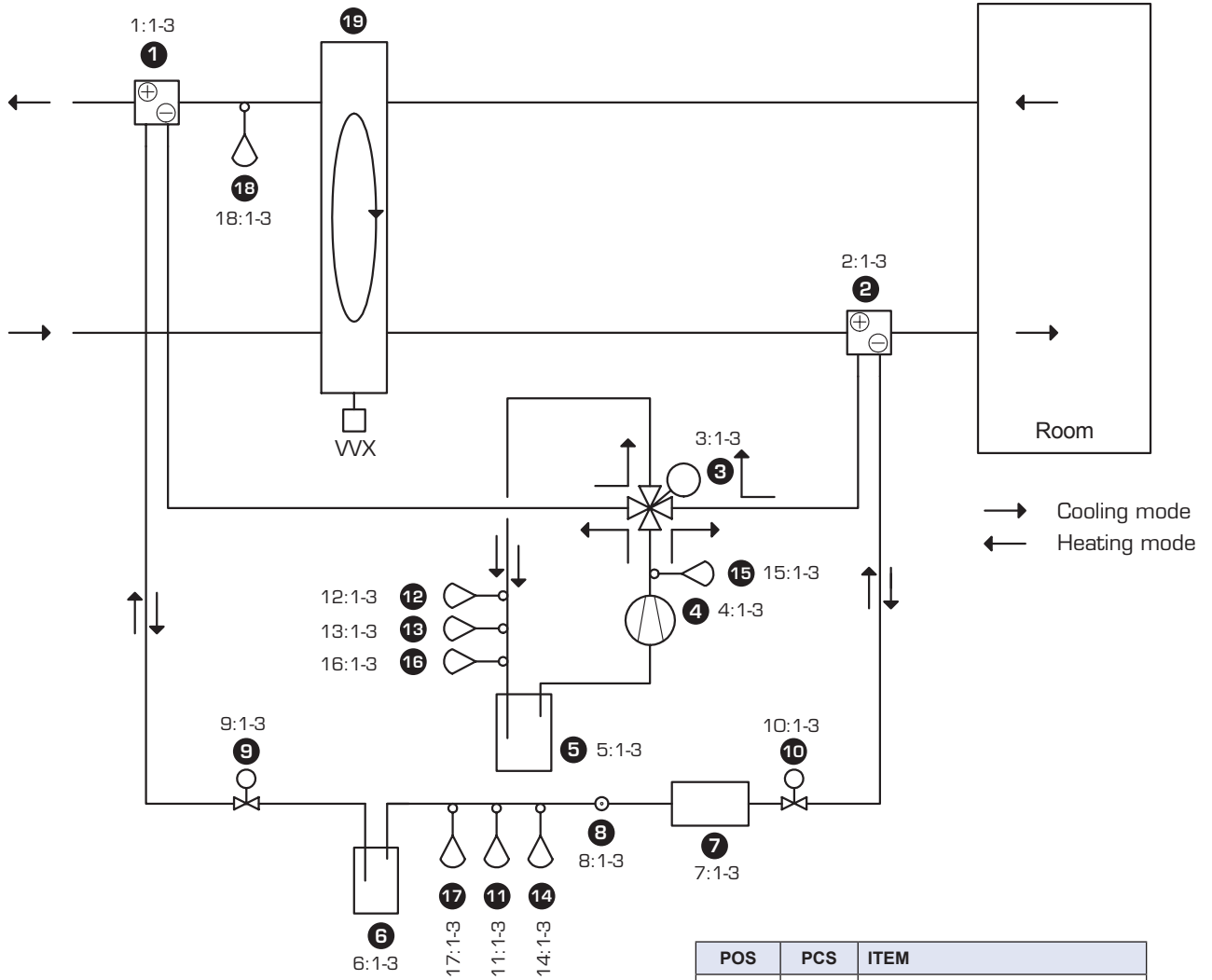

Size 008-032 1 circuit
 Size 041-050 2 circuits

POS	PCS	ITEM
1:1-3	1	Exhaust air coil
2:1-3	1	Inlet air coil
3:1-3	1	4 way valve
4:1-3	1	Compressor
5:1-3	1	Liquid separator
6:1-3	1	Reciver
7:1-3	1	Filterdrier
8:1-3	1	Sightglass
9:1-3	1	EEV 2
10:1-3	1	EEV 1
11:1-3	1	High pressure sensor
12:1-3	1	Low pressure sensor
13:1-3	1	Suction temp sensor
14:1-3	1	Liquid temp sensor
15:1-3	1	Discharge temp sensor
16:1-3	1	Low pressure service connector
17:1-3	1	High pressure service connector
18:1-3	1	Extract air sensor
19	1	Rotor

ReCooler HP

Hand terminal ReCooler HP

The ReCooler HP is equipped with an own display. This display is used for detail information of the Re-Cooler HP system.

When the unit is powered up the following screen is displayed.



The user is presented with the option to select a desired language. The ENTER button is used to change through the list of available languages and the ESC button selects the highlighted language.

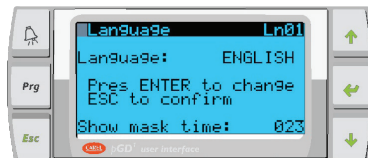

The home screen displays information related to the current status of the unit.



This screen displays information related to the current status (operation mode) of the coils (condensing/evaporating) and whether the AHU is configured with supply air in the upper or lower level.

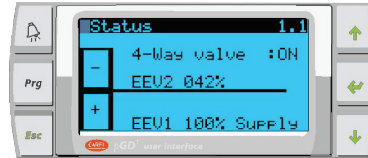

Displays information related to the temperature and pressure of the system.

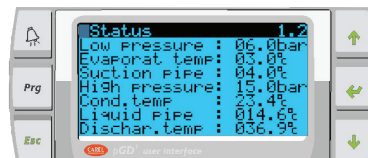

Displays information regarding the status of the unit.



Select signal reference for controlling the ReCooler. Analog signals or Modbus for controlling from BMS. eQ air handling unit with control uses Modbus.

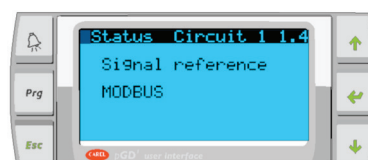

Software information of the system.



Reset alarms can be restarted 5 times in 24 hours.

If more alarms are generated then manual reset will be necessary. To restart the unit in this case press 5 sec on the Alarm button on the handheld terminal for the ReCooler HP.

Web interface

Two **web interfaces** are available for the eQ PRIME for monitoring, operation and parameterisation via standard web browsers. This section of the instructions describes the integrated web interface that is always included in the control unit.

The SmartWeb accessory is described in the separate instructions entitled 9092 SE.

Procedure

1. Connect the control unit to an Ethernet network, via the RJ45 connector.
2. Configure the TCP/IP settings in the control unit.
3. Open the web browser, enter address and log in.

TCP/IP settings

Go to:

MAIN INDEX → SYSTEM OVERVIEW →
COMMUNICATION → TCP/IP

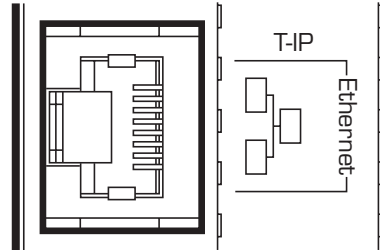

Explanation

DHCP Shows the type of address allocation

- Active: The DHCP server allocates addresses.
- Passive: Fixed IP address.

Actual IP: Shows the actual IP address.
 Actual Mask: Shows the actual mask address.
 Act. Gateway: Shows the actual gateway address.
 Given IP: The new IP address is specified here. Finish with #.
 Given Mask: The new mask address is specified here. Finish with #.
 Given Gateway: The new gateway address is specified here. Finish with #.

100 MBit: Actual transmission rate

- Active: rate of 100 Mbit
- Passive: rate of 10 Mbit

Name: Shows name of controller.
 MAC: Shows controller's MAC address.
 Link: Shows Ethernet connection.

- Passive: No Ethernet connection.
- Active: Ethernet connection.

User name: For logging on to web interface. Finish with #.
 Password: For logging on to web interface. Finish with #.

FTP user name: For FTP connection (not used).
 FTP password: For FTP connection (not used).
 Restart: Restart is always required after making changes in this menu. Change to Execute to restart the control unit.

TCP/IP	
DHCP	Passive
Actual IP	172.16.189.31
Actual Mask	255.255.255.0
Act. Gateway	172.16.189.1
Given IP	172.16.189.31
Given Mask	255.255.255.0
Giv Gateway	172.16.189.1
100 MBit	Active
Name	POL638_058238
MAC	00-A0-03-05-82-38
Link	Active
User name	-
	ADMIN
Password	-
	SBTAdmin!
FTP user name	-
	ADMIN
FTP password	-
	SBTAdmin!
After modification of values	
Restart	

Web interface

Web browser

1. Open the web browser and enter address (Target name or IP address).
2. Enter user name [ADMIN].
3. Enter password [SBTAdmin!].
4. Confirm with OK.

The web browser will open and is now ready to use.

The interface layout is similar to that of the handheld terminal. To open a sub-menu, click the green arrow at the right side of the row.

To change parameters, click the red arrow at the right side of the row. An editing field will open at the bottom edge of the page. To confirm the change, click save (floppy disk symbol). To abandon the change, click the return arrow.

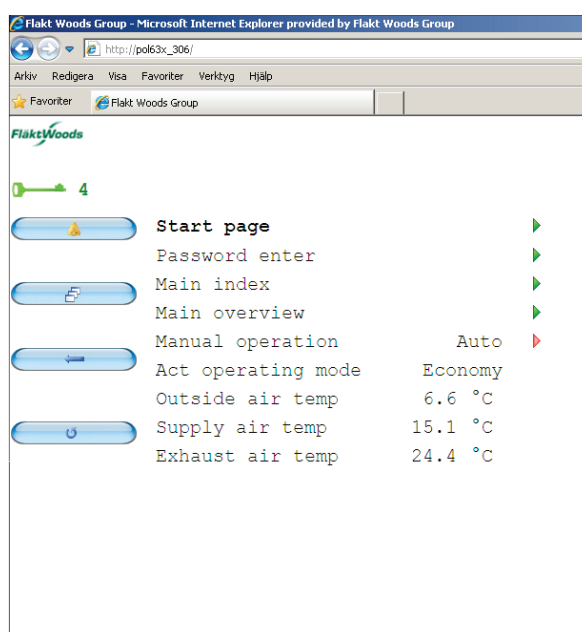

Modem/sms

The eQ PRIME can be supplied with a factory installed **modem** for alarm monitoring via **sms**. Most of the settings are configured at the factory, but some need to be configured on site.

SIM card

1. Make sure that the supply voltage to the unit is switched off before starting work.
2. Press the small button on the modem to eject the SIM card holder.
3. Insert the SIM card in the holder.
4. Insert the SIM card holder back into the modem.
5. Switch on the power.

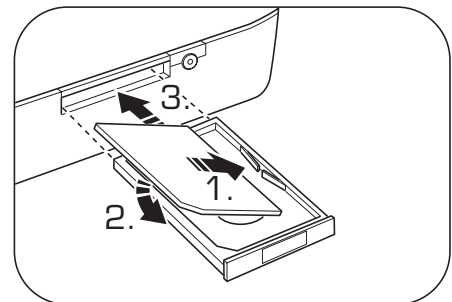
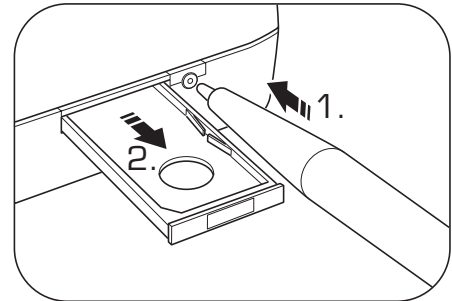

PIN code and coverage

The next step is to insert the **PIN code** and adjust the antenna to obtain optimum coverage. Go to the following menu:

MAIN INDEX → SYSTEM OVERVIEW →
COMMUNICATION → SMS →
SETTINGS MODEM

Do not hesitate to contact Fläkt Woods support for advice and assistance. Tel. +46 36 193003.

Language and telephone number

These settings are also in the above menu.

- Set the language for the sms alarm with the parameter SMS Language.
- The control unit can handle up to four telephone numbers Phone nbr 1, Phone nbr 2, Phone nbr 3 and Phone nbr 4.
Enter the telephone numbers without spaces
Finish with #.
Separate schedulers determine which telephone number the alarm will be linked to, see below.

1. Go to the parameter PIN and enter the correct PIN code. If PIN code verification is not activated, this step is not necessary.
2. Check that OK is displaced in the Status row. If not, check all the connections.
3. Check Signal strength GSM. If necessary, adjust the antenna position.
If it is difficult to find a good position, the included antenna can be replaced with a different model. Connect the modem via a 50 FME (male) coaxial outlet.

Schedulers for sms alarm

Finally, set the **schedulers** for the **sms alarm**.

Go to the following menu:

MAIN INDEX → SYSTEM OVERVIEW →
COMMUNICATION → SMS →
SMS ACT NUMBER

These schedulers are set in exactly the same way as the control unit's normal schedulers for handling operation, see page 22. The only difference is that with the sms alarm, the schedulers handle the telephone numbers Phone nbr 1, Phone nbr 2, Phone nbr 3 and Phone nbr 4.

Questions and answers

■ Display

The unit and control system are connected to the mains.

The LEDs on the controller shine and flash, but the display says “Lost connection”.

How can I resolve the problem?

- Disconnect the display cord from the unit. Reconnect the cord to the unit.
- Switch the main power switch off and on.
- If the above suggestions do not help, press and hold Esc. for a few seconds. Go to HMI settings. Specify the version (first row). Then contact TSS Controls +46 36 193003.

How do I switch to English in the display?

1. Go to the following menu:
MAIN INDEX → SYSTEM OVERVIEW → LANGUAGE SELECTION
2. Change parameter:
Current Language

■ Pressure/Flow

A flow shown in HMI does not correspond with the measured flow.

- Stop the unit without switching off the power. Open the flow sensor and depress the push button for 15 seconds.
- Check that the unit is dimensioned for the desired flow.
- Check that the pressure hoses are correctly connected to the pressure sensors, and that the cover of the pressure outlet has not fallen off.
- If the above suggestions do not help, contact TSS Controls, Tel. +46 36 193003.

The desired pressure setpoint/flow setpoint can not be achieved. Why?

- External pressure drop too high.
- A pressure hose may have become disconnected. Stop the unit, open the hatches, check and rectify if necessary.
- The cap on an unused measurement nipple (located on the door pillar of the air handling unit) may have come off. Reinstall the cap.
- Check that the dampers open.
- Check the filter pressure drop.
- Stop the unit without switching off the power. Open the flow sensor and depress the push button for 15 seconds.
- Check that the pressure hoses are correctly connected. P1 is used for flow measurement and P2 is used for filter monitoring.
- If the above suggestions do not help, contact TSS Controls, Tel. +46 36 193003.

Why does the actual flow/pressure setpoint deviate from the setpoint values entered under “Flow controller” and “Pressure controller” respectively?

- The entered setpoint values may deviate from the actual values if fan compensation is activated.

Questions and answers

■ Temperature

The controller cannot maintain the set temperature. What can be wrong?

- Is the heating coil/cooling coil dimensioned for the prevailing outdoor temperature?
 - Check whether the water temperature to the heaters is sufficiently high/low.
 - Check whether there is a power supply to the electric heater.
 - Ensure that there are no windows or doors open.
-

Temperatures have been checked. One sensor always shows 1.8 °C too little. Do we need to replace the sensor?

- No. It can be adjusted under:
MAIN INDEX → UNIT → INPUTS → TEMPERATURE
 - Each sensor has a parameter, Calibration, which can be used to adjust the value.
-

Why does the current temperature setpoint deviate from the values we have entered under "Room/extract air ctrl"?

- If the unit is equipped with room and extract air control, the temperature is controlled by two controllers (a room/extract air controller and a controller for the supply air temperature). The setpoint entered on the room/extract air controller is used to generate the setpoint on the supply air controller. Consequently, the setpoint for the supply air temperature will vary with the energy requirement in the room or extract air.
 - The Summer/Winter compensation function may be activated. Compensation displaces the setpoint depending on the prevailing outdoor temperature.
 - If the selected setpoints lie outside the permitted range, a setpoint corresponding to the maximum or minimum limits will be obtained (depending on whether the selected setpoint is too high or too low).
-

The electric heater is tripped by the automatic thermal overload protection. How do I rectify the fault?

- Air supply temperature is too high. Reduce the setpoint or increase the flow.
-

The air handling unit is switched off yet the pump to the heating coil is running. Is something wrong?

- If the temperature of the return water from the heating coil is low, the frost protection controller runs the pump to the heating coil, so that the coil does not risk freezing when the unit starts.
 - The pump is exercised every Monday at 12:00 or is set to continuous operation.
-

Questions and answers

■ Operation

How do I set the same schedule for every day?

- Use the copy function, Copy Schedule, to copy the Monday schedule to Tuesday to Friday.

How can I set the timer so that the unit is switched off on Saturdays and Sundays?

- Set the first scheduler for Saturday and Sunday to Off at, for example, 00:00. Specify the following schedulers for Saturday and Sunday using asterisks, *.

How does start up work if I have pressure controlled supply air with slave controlled extract air?

- The extract air fan regulates towards a fixed setpoint until the supply air fan has started. This value can be changed on the controller.
-

■ Miscellaneous

Why is the terminal block Fire (73-74) strapped?

- The contact function for the fire alarm is normally closed (NC) on delivery. This means that the unit would generate an alarm if the inputs were not strapped.

What is the meaning of alarm classes A, B and C?

- A alarm: Danger or high (unit stops).
- B alarm: The unit generating the alarm is malfunctioning.
The unit continues running.
- C alarm: Only warning in display.

All or parts of the unit are malfunctioning.

- Check internal cables. Note that the internal signal cables are daisy chained (Modbus).

The rotary heat exchanger rotates in the wrong direction.

- Switch off the power. Open the rotor's drive unit. Change the position of DIP switch 1. Replace the drive unit's cover.
-

Alarm guide

When the red LED on the handheld terminal starts to flash an alarm has been generated. To check the alarm, press the alarm button (4) once. Detailed information is displayed. To reset the alarm press the button again and reset it by changing Confirm/Reset to Active. If the LED lights continuously an alarm persists.

General fault-tracing

1. Read off the alarm from the handheld terminal.
2. Check the connections on terminal blocks and quick connectors.

3. Check the component from which the alarm was generated.
4. Check the connection of the component.
5. Check the contact function on the digital alarms in the controller, and compare them with the drawing and component.
6. Check the parameter settings. Below is a list of possible error messages and proposed corrective actions/causes.

Alarms	Alarm text	Cause	Action	Type
Fire alarm	Fire alarm: Alarm	Terminal blocks 73-74 in control cabinet indicate alarm, normally caused by alarm from fire control unit.	<ul style="list-style-type: none"> • Check connected fire control unit. • Check contact function for digital input 5, compare with function obtained from fire control unit . 	A
Fire alarm 2	Fire alarm input 2	Terminal blocks 127-128 in control cabinet indicate alarm, normally caused by alarm from fire control unit.	<ul style="list-style-type: none"> • Check connected fire control unit • Check contact function for digital input 5, compare with function obtained from fire control unit 	A
Calibration active mixing	Active mixing calibration:Alarm	Needed calibration for active mixing not done	Execute the calibration sequence for active mixing. See page [page for active mixing]	C
Hex pressure alarm	HEX pressure drop	The measured value from the differential pressure sensor over the heat recovery wheel is outside the permitted range.	<ul style="list-style-type: none"> • Check the measured value using the handheld terminal • Check the setting in the differential pressure sensor and calibrate it • Check connections • Check that the cables are intact 	A
Balance pressure alarm	Balance pressure	The measured value from the differential pressure sensor over the mixing damper is outside the permitted range.	<ul style="list-style-type: none"> • Check the measured value using the handheld terminal • Check the setting in the differential pressure sensor and calibrate it • Check connections • Check that the cables are intact 	A
Communication alarm	Com.Alarm Sply.fan Com.Alarm Exh.fan Com.Alarm Sensors Com.Alarm Rev.Cooler	Sensor or function on Modbus can not communicate with the controller.	<ul style="list-style-type: none"> • Control the signal cable that all connections is connected. 	B
Alarm pump heating	Htg pump alarm: Alarm	Terminal blocks 67-68 in control cabinet indicate alarm, normally caused by the motor protection in the heating water circulation pump.	<ul style="list-style-type: none"> • Check motor protection in heating circulation pump. • Check contact function for digital input 2, compare with function obtained from pump. 	B

Continued on next page

Alarm guide

Alarms	Alarm text	Cause	Action	Type
Alarm electric heater	EI htg alarm: Alarm	Terminal blocks 67-68 in control cabinet indicate alarm, normally caused by thermal overload protection in the electric heater.	<ul style="list-style-type: none"> • Check thermal overload protection in electric heater. • Check contact function for digital input 2, compare with function obtained from electric heater. 	A
Alarm recovery unit	Heat recovery alarm: Alarm		<ul style="list-style-type: none"> • See other alarm points from the recovery unit for further details. 	B
Low voltage to rotor operation	Hrec. Unit Volt low: Alarm	The incoming supply voltage is too low for rotor operation.	<ul style="list-style-type: none"> • Check the supply voltage. 	C
High voltage to rotor operation	Hrec. Unit Volt high: Alarm	The incoming supply voltage is too high for rotor operation.	<ul style="list-style-type: none"> • Check the supply voltage. 	C
Broken rotor belt	Hrec. Unit Brokenbelt: Alarm	The drive belt on the rotor has become detached or loose.	<ul style="list-style-type: none"> • Check that the drive belt has not become detached or loose. 	C
Rotor motor locked/blocked	Hrec. Unit Motor blocked: Alarm	The rotor moves too slowly or is jammed.	<ul style="list-style-type: none"> • Check that the rotor is not moving more slowly than usual and is not jammed. 	C
Faulty sensor on rotor motor	Hrec. Unit Sensor error: Alarm	Faulty sensor in rotor motor.	<ul style="list-style-type: none"> • Contact Fläkt Woods support. 	C
High temperature in rotor motor	Hrec. Unit High temp: Alarm	Motor has been running hot.	<ul style="list-style-type: none"> • Check that the rotor is not moving more slowly than usual and is not jammed. 	C
DIP switch error in rotor operation	Hrec Unit DIP error: Alarm	DIP switch has unauthorised setting.	<ul style="list-style-type: none"> • Reset to factory setting. 	C
Cooling pump alarm	Cooling pump alarm: Alarm	Terminal blocks 61-62 in control cabinet indicate alarm, normally caused by motor protection in the chilled water circulation pump.	<ul style="list-style-type: none"> • Check motor protection in chilled water circulation pump. • Check contact function for digital input 1, compare with function obtained from pump. 	B
Alarm DX cooling	Cooling DX alarm	Terminal blocks 61-62 in control cabinet indicate alarm, normally caused by alarm from condenser.	<ul style="list-style-type: none"> • Check alarm from condenser. • Check contact function for digital input 1, compare with function obtained from condenser. 	B
Alarm supply air filter	Supply filter alarm	The measured differential pressure over the supply air filter exceeds the set alarm level, normally due to soiling.	<ul style="list-style-type: none"> • Check the supply air filter and replace if necessary. • If the pressure drop over the supply air filter is too high or too low in relation to the desired final pressure drop. Adjust the alarm level using the handheld terminal. 	B
Alarm, extract air filter	Exhaust Filter alarm	The measured differential pressure over the extract air filter exceeds the set alarm level, normally due to soiling.	<ul style="list-style-type: none"> • Check the extract air filter and replace if necessary. • If the pressure drop over the extract air filter is too high or too low in relation to the desired final pressure drop. Adjust the alarm level using the handheld terminal. 	B

Continued on next page

Alarm guide

Alarms	Alarm text	Cause	Action	Type
Pre-alarm supply air filter	Supply Filter Pre-alarm	The measured differential pressure over the supply air filter exceeds the set value for the pre-alarm, normally because the filter soon needs replacing.	<ul style="list-style-type: none"> • Check the pressure drop over the supply air filter. Keep a new filter ready and wait until the message 'Alarm supply air filter' appears. • If the pressure drop over the supply air filter is low in relation to the desired final pressure drop. Adjust the level for the pre-alarm using the handheld terminal. 	C
Pre-alarm, extract air filter	Exhaust Filter Pre-alarm	The measured differential pressure over the extract air filter exceeds the set value for the pre-alarm, normally because the filter soon needs replacing.	<ul style="list-style-type: none"> • Check the pressure drop over the extract air filter. Get a new filter and wait until the message 'Alarm extract air filter' appears. • If the pressure drop over the extract air filter is low in relation to the desired final pressure drop. Adjust the level for the pre-alarm using the handheld terminal. 	C
Exception alarm, supply air fan	Sply fan deviation: Active	The measured supply airflow/pressure has deviated from the setpoint for an abnormally long time.	<ul style="list-style-type: none"> • Check that the dampers open. • Check the filter pressure drop. • Check that the pressure sensor is correctly connected. The fan should be connected to P1. • Calibrate the pressure sensor (stop the unit and depress the button on the sensor for 15 s). • Check cap on unused measurement nipples. • Check that the pressure hoses have not been disconnected. • Check the external pressure drop. 	A
Exception alarm, extract air fan	Exh fan dev alarm: Active	The measured extract airflow/pressure has deviated from the setpoint for an abnormally long time.	<ul style="list-style-type: none"> • Check that the dampers open. • Check the filter pressure drop. • Check that the pressure sensor is correctly connected. The fan should be connected to P1. • Calibrate the pressure sensor (stop the unit and depress the button on the sensor for 15 s). • Check cap on unused measurement nipples. • Check that the pressure hoses have not been disconnected. • Check the external pressure drop. 	A
Operating period alarm	Fan op hours alarm	The unit's operating period has reached the alarm limit. This function is usually used to signal that maintenance is due.	<ul style="list-style-type: none"> • Reset the operation time counter and acknowledge the alarm. • If desired, the alarm limit can be changed or the function can be completely disabled via the handheld terminal. 	B
Alarm supply air fan	Supply fan alarm: Alarm	See alarm number on page 52.	<ul style="list-style-type: none"> • Go the the Main index → Unit → Fan control → Supply air fan → Alarm number. 	B
Alarm extract air fan	Exhaust fan alarm: Alarm	See alarm number on page 52.	<ul style="list-style-type: none"> • Go the the Main index → Unit → Fan control → Extract air fan → Alarm number. 	B
Supply air flow below range	Supply air flow: under range	The differential pressure sensor for the supply air fan is faulty or disconnected.	<ul style="list-style-type: none"> • Check that the differential pressure sensor on the supply air fan is connected. • Calibrate the differential pressure sensor (stop the unit and depress the button on the sensor for 15 s). 	A

Continued on next page

Alarm guide

Alarms	Alarm text	Cause	Action	Type
Manually controlled fans	Fan manual mode	One or more frequency converters are in manual mode.	<ul style="list-style-type: none"> Check that the frequency converter is in the operating mode "AUTO" On. 	A
Extract air flow below range	Exhaust air flow: under range	The differential pressure sensor for the extract air fan is faulty or disconnected.	<ul style="list-style-type: none"> Check that the differential pressure sensor on the extract air fan is connected. Calibrate the differential pressure sensor (stop the unit and depress the button on the sensor for 15 s). 	A
Temperature above range	Temperature: over range	A temperature sensor measures a higher temperature than the set alarm limit, normally due to an electrical fault (does not apply to sensors in water circuits), open circuit/short circuit.	<ul style="list-style-type: none"> Check the measured values using the handheld terminal to identify which sensor is measuring the high temperature. If a high (but reasonable) temperature is measured from a water circuit, raise the alarm level using the handheld terminal. Check connections. Check that the cables are intact. Measure the temperature sensor function using a multimeter. 	B
Abnormal temperature	Temperature: XXX°	A temperature sensor measures temperatures outside the normal measuring range, usually caused by an electrical fault, open circuit/short circuit.	<ul style="list-style-type: none"> Check the measured values using the handheld terminal to identify which sensor is measuring an abnormal temperature. Check connections. Check that the cables are intact. Measure the temperature sensor function using a multimeter. 	A
Temperature sensor not connected	Temperature no sensor	The control unit does not detect that the temperature sensor is connected, even though it is activated in the software.	<ul style="list-style-type: none"> Check the measured values using the handheld terminal to identify which sensor has no measured values. Check connections. Check that the cables are intact. Measure the temperature sensor function using a multimeter. 	B
Temperature error other	Temperature other	Temperature sensor incorrectly connected.	<ul style="list-style-type: none"> Check the measured values using the handheld terminal to identify which sensor has no measured values. Check connections. Check that the cables are intact. Measure the temperature sensor function using a multimeter. 	B
Fire indication extract air temperature	Exh tmp fire alarm	The measured values from the extract air temperature sensor are high; this normally indicates fire/flue gas.	<ul style="list-style-type: none"> Check the extract air temperature. Adjust if necessary (false alarm) using the handheld terminal. 	A
Fire indication supply air temperature	Supply tmp fire alm	The measured values from the supply air temperature sensor are high; this normally indicates fire/flue gas.	<ul style="list-style-type: none"> Check the supply air temperature. Adjust if necessary (false alarm) using the handheld terminal. 	A
Frost protection	Heating frost tmp	Control unit measures low return water temperature from heating coil, may also be caused by electrical fault.	<ul style="list-style-type: none"> Check the return water temperature using the handheld terminal. Check connections. Check that the cables are intact. Measure the temperature sensor function using a multimeter. 	A

Continued on next page

Alarm guide

Alarms	Alarm text	Cause	Action	Type
Frosting rotor	Hrec frost pressure	The differential pressure sensor over the rotor measures a large pressure difference, usually caused by frosting of the rotor.	<ul style="list-style-type: none"> • Check the measured value using the handheld terminal. • Check the heat exchanger. Is it frosted? • Adjust the frosting controller. 	A
Deviation room temperature	Room tmp dev alarm	The measured temperature from the room sensor has deviated from the setpoint for an abnormally long time.	<ul style="list-style-type: none"> • Check the measured value using the handheld terminal. • Check the functions in the control sequence is the heat exchanger functioning correctly? Are the pilot valve and actuator functioning correctly (connection)? Is there access to heating and cooling? Is the electric heater functioning correctly (connection)? • Is there another factor in the room that may have caused the temperature deviation (e.g. open windows, incorrectly positioned sensor)? • If necessary, the alarm limit and alarm delay can be adjusted using the handheld terminal. 	B
Deviation supply air temperature	Sply tmp dev alarm	The measured temperature from the supply air sensor has deviated from the setpoint for an abnormally long time.	<ul style="list-style-type: none"> • Check the measured value using the handheld terminal. • Check the functions in the control sequence. Is the heat exchanger functioning correctly? Are the pilot valve and actuator functioning correctly (connection)? Is there access to heating and cooling? Is the electric heater functioning correctly (connection)? • Is there another factor that may have caused the temperature deviation (e.g. incorrectly positioned sensor)? • If necessary, the alarm limit and alarm delay can be adjusted using the handheld terminal. 	B
Deviation extract air temperature	Exh tmp dev alarm.	The measured temperature from the extract air sensor has deviated from the setpoint for an abnormally long time.	<ul style="list-style-type: none"> • Check the measured value using the handheld terminal. • Check the functions in the control sequence. Is the heat exchanger functioning correctly? Are the pilot valve and actuator functioning correctly (connection)? Is there access to heating and cooling? Is the electric heater functioning correctly (connection)? • Is there another factor that may have caused the temperature deviation (e.g. open windows, incorrectly positioned sensor)? • If necessary, the alarm limit and alarm delay can be adjusted using the handheld terminal. 	B
Efficiency alarm	Hrec efficiency	The measured efficiency of the rotor is lower than the set threshold value.	<ul style="list-style-type: none"> • Check the temperatures using the handheld terminal. • Check whether the heat exchanger is frosted or soiled. • Check the temperature sensors' location. 	B
I/O double configured	Doubled config IO: Yes	Two or more functions are configured on the same input or output.	<ul style="list-style-type: none"> • Contact Fläkt Woods tel.: +46 36 193003. 	A
I/O not configured	Not config IO: Yes	One or more functions have not been allocated outputs or inputs.	<ul style="list-style-type: none"> • Contact Fläkt Woods tel.: +46 36 193003. 	A

Continued on next page

Alarm guide

Alarms	Alarm text	Cause	Action	Type
Modbus alarm	Modbus comm alarm	Faulty Modbus connection, usually caused by internal error in the unit.	<ul style="list-style-type: none"> • Check connection of internal signal cables in unit. • Check settings and connection to BMS (if applicable). • Contact Fläkt Woods tel.: +46 36 193003 	
Supply air pressure sensor	Supply air pressure: Alarm	The measured value from the differential pressure sensor in the supply air duct is outside the permitted range.	<ul style="list-style-type: none"> • Check the measured value using the handheld terminal. • Check the setting in the differential pressure sensor and calibrate it. • Check connections. • Check that the cables are intact. • Check the measurement signal using a multimeter. • Check the sensor's position in the duct system. • Check the external pressure drop. • Check the fan and damper. • Check the filter. • If necessary, the alarm limit can be changed using the handheld terminal. 	
Extract air pressure sensor	Exhaust air press: Alarm	The measured value from the differential pressure sensor in the extract air duct is outside the permitted range.	<ul style="list-style-type: none"> • Check the measured value using the handheld terminal. • Check the setting in the differential pressure sensor and calibrate it. • Check connections. • Check that the cables are intact. • Check the measurement signal using a multimeter. • Check the sensor's position in the duct system. • Check the external pressure drop. • Check the fan and damper. • Check the filter. • If necessary, the alarm limit can be changed using the handheld terminal. 	A
Manual operation	Manual mode: Alarm	One or more functions in the control unit have been operating in manual mode for a long time.	<ul style="list-style-type: none"> • Reset the functions to AUTO. • If necessary, the alarm limit can be changed using the handheld terminal. 	B
Zone control alarm	Zone controller: Alarm	An alarm can be sent from an external control cabinet for separate zones or external fans.	<ul style="list-style-type: none"> • Check alarm in external control cabinet. • See separate instructions. 	B
Aux alarm	Aux. alarm	The control unit detects that an alarm is connected to a digital input that has been reconfigured for AUX alarm. For example: B alarm from fire control unit.	<ul style="list-style-type: none"> • Check connected function. • Check the connection and check that the cables are intact. • If necessary, the contact function can be changed using the handheld terminal. 	B

Continued on next page

Alarm guide

Alarms	Alarm text	Cause	Action	Type
Fault handheld terminal	Conn. Lost	The handheld terminal is unable to communicate with the control unit	<ul style="list-style-type: none">• Disconnect and reconnect the cable from the handheld terminal to the control unit• If the fault persists, contact Fläkt Woods tel.: +46 36 193003	—
Deviation alarm humidity in supply air	Sply hum deviation	The measured humidity in the supply air has deviated from the setpoint for a abnormally long time.	<ul style="list-style-type: none">• Check the measured value using the handheld terminal.• If necessary, the alarm limit and alarm delay can be adjusted using the handheld terminal.	B
Deviation alarm humidity in the room or in the extract	Room hum deviation	The measured humidity in the room or extract air has deviated from the setpoint for a abnormally long time.	<ul style="list-style-type: none">• Check the measured value using the handheld terminal.• If necessary, the alarm limit and alarm delay can be adjusted using the handheld terminal.	B

Alarm list supply air and extract air fans

PM-Motors with FC101, FC102 and FC106

Error code	Fault number	Alarms	Cause of problem
14	4	Phase missing	Network phase loss or too high supply voltage imbalance. Check the supply voltage. See parameter 14-12.
11	7	DC overvoltage	The intermediate circuit voltage is higher than the threshold value.
10	8	DC undervoltage	The intermediate circuit voltage drops below the threshold value for low voltage warning.
9	9	Converter overloaded	The load exceeds 100 % over too long a period.
8	10	Overheating	The motor has overheated because load has exceeded 100 % for too long. See parameter 1-90.
7	11	Thermistor alarm	The thermistor or thermistor connection is disconnected. See parameter 1-90.
5	13	Overvoltage	The inverter's upper current limit has been exceeded.
2	14	Earth fault	Discharge from output phases to ground.
12	16	Short circuit	Short circuit in motor or on motor terminal blocks.
4	17	Communication error	No communication with frequency converter. See parameter group 8-0X.
19	30	Phase U is missing	Motor phase U is missing Check the phase. See parameter 4-58.
20	31	Phase V is missing	Motor phase V is missing Check the phase. See parameter 4-58.
21	32	Phase W is missing	Motor phase W is missing Check the phase. See parameter 4-58.
17	38	Internal error	Contact Fläkt Woods support.
28	44	Earth fault	Discharge from output phases to ground.
23	47	Fault 24VDC	24 V DC supply may be overloaded.
25	48	Low control voltage	Low control voltage. Contact Fläkt Woods support.
15	51	AMA fault	The settings for motor voltage, motor current and motor output are probably incorrect. Check the settings.
25	59	Current limit	The current is higher than the value in parameter 4-18, Current limit.
44	60	External stop	External stop has been activated. To resume normal operation, power the terminal block that is programmed for External stop with 24 V DC and reset the frequency converter (via serial communication, digital I/O or by pressing the reset button on the keypad).
1	69	Temperature alarm	The temperature sensor on the power card is either too hot or too cold.
29	80	Reset alarm	Restores all parameters to their factory-set values.
47	87	DC Brake	The frequency converter has DC braking.
40	95	Incorrect load	The torque is lower than the torque level set for no load, which indicates a broken belt. See parameter group 22-6.

Updating from an SD card

The controller is equipped with an SD card reader. An **SD card** can be used to update the software and configurations.

Instructions for loading configurations via memory card:

- Insert the memory card supplied by Fläkt Woods into the card reader in the control unit.
- Then go to the following menu using the handheld terminal:

MAIN INDEX → SYSTEM OVERVIEW →
SAVE/RESTORE

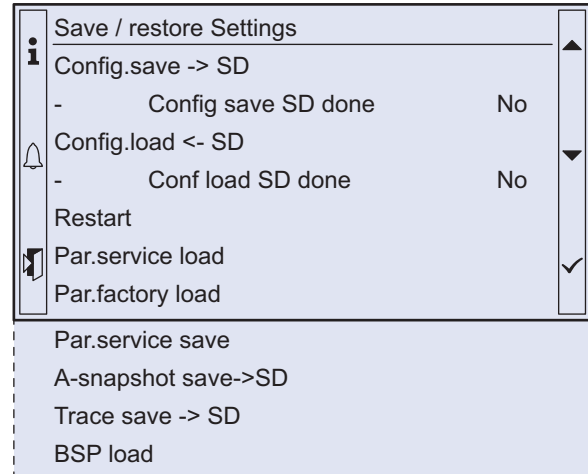

- Upload the settings from the memory card with the parameter “Config load <- SD”.
- When the parameters have been loaded to the control unit, restart the eQ PRIME unit using the “Restart” function in the above menu, or by switching off and then switching on the incoming power.

Fläkt Woods support: www.flaktwoods.co.uk



+ 46 (0) 36 19 30 03

Installation and wiring is described in
eQ Prime Installation Guide.

This document describes commissioning.



WE BRING **BETTER AIR**[™] TO LIFE

With over a century of innovation and expertise to share with our customers, Fläkt Woods is a global leader in Air Technology products and solutions. We specialize in the design and manufacturing of a wide range of products and solutions for Air Movement, Air Treatment, Air Distribution, Air Management and Air Diffusion with focus on two major benefits – **Air Comfort** and **Fire Safety**. With market presence in 65 countries we are in a unique position to be a local supplier and an international partner in our customer's projects.

Our product brands such as SEMCO[®], eQ[®], eQ Prime[®], JM Aerofoil[®], Econet[®], Veloduct[®], Optivent[®], Econovent[®] and Cleanvent[®] are well-known and trusted by customers all over the world to deliver high quality and energy efficient solutions.

» To learn more about our offering and get in contact with your nearest sales representative please visit www.flaktwoods.com

WWW.FLAKTWOODS.COM

eQ PRIME COMMISSIONING | 9355 GB